



## ERGONOMICS AND AIRCRAFT SEATS: A STUDY OF COMFORT AND WELL-BEING FOR THE USER

\* Ana Carolina Russo <sup>1</sup>, Edison Russo <sup>2</sup>, Carolina Machado Silberschmidt <sup>3</sup>, Giuliana Mendes Montini <sup>4</sup>,  
Juliana Blasbalg <sup>5</sup>

<sup>1</sup>Escola Superior de Engenharia e Gestão – ESEG, São Paulo, SP, Brasil

<sup>2</sup>Centro Universitário das Faculdades Metropolitanas Unidas – FMU, São Paulo, SP, Brasil

<sup>3, 4, 5</sup> Centro Universitário, Instituto Mauá de Tecnologia – IMT, São Caetano do Sul, SP, Brasil

\*E-mail: [ana.russo@eseg.edu.br](mailto:ana.russo@eseg.edu.br)

### ABSTRACT

---

In the 21st century, passengers in the economy class of commercial flights have still shown displeasure with the seats offered by airlines. For this reason, this work aimed to perform an ergonomic analysis in a standard airplane seat model, in order to verify its potential points of improvement, and thus propose a new model that is within the standards recommended by ergonomics. Simulations were performed in the CATIA Ergonomics For Car Design software, which uses the RULA method to generate an ergonomic evaluation. The simulations were applied to six digital mannequins of five different nationalities, including German, American, French, Indian and Japanese, of both sexes, with the average dimensions of each of the populations studied. In this way, it was possible to cover a majority of the world's population with the resources available through the software. The results of the simulations indicated that the main triggering factor of discomfort in the passengers was the width of the armchair, which had smaller dimensions than the appropriate ones, causing users to have to shrink to accommodate the seats. This factor served as the basis for the creation and construction of the new armchair model that was later designed using the CATIA V6 and 3D Experience software. In order not to reduce the number of seats inside the aircraft, the arrangement of the seats inside the aircraft was changed using geometric calculations by applying the Pythagorean theorem and the Triangle Similarity, to determine how much the dimensions could be changed. The modifications made to the chair analyzed resulted in ergonomic improvements for all mannequins submitted to the tests providing the same greater comfort and safety during short and long trips.

**Keywords:** Ergonomics in aircraft. Airplane seat. Ergonomic simulation. RULA method. Seat design.

## 1. INTRODUCTION

According to a research published in The New York Times in 2016 (Rosenbloom, 2016), one in twenty people is justified in complaining about the extreme discomfort caused by economy class airplane seats. The study highlights the fact that the aircraft seats do not conform to human anatomy, which can lead to a range of health problems for passengers, such as back pain, spine issues, neck discomfort, and poor posture. "Seats have been a persistent challenge for our customers," stated Shemm, Vice President of Finance and Operations at Boeing Commercial Airplanes (Vinhos, 2018).

Alongside the desire to provide comfortable seats for their passengers, airlines constantly grapple with the issue of excess weight within the aircraft. According to a report from 2018 by the Todos a Bordo Blog (Casagrande, 2018), United Airlines claimed to save \$3.2 million in fuel costs annually, simply by reducing the weight of certain items carried on board, such as thinner magazines and some beverages. Therefore, reducing the weight of airplane seats would result in a significant reduction in the overall aircraft weight, leading to substantial economic benefits for the airline.

Another factor to consider is the limited available space within airplanes, which leads to one of the primary concerns for airlines: maximizing the number of passengers on each flight. Consequently, with the aim of transporting the maximum number of passengers per trip, airlines have significantly reduced the spacing between seats, often neglecting the comfort and well-being of those using the seats.

As a consequence of airlines prioritizing passenger comfort less, there has been a significant increase in complaints related to seats. This increase prompted the National Civil Aviation Agency (ANAC) in 2010 to create the ANAC Label. Its purpose is to inform passengers at the time of ticket purchase about the characteristics of the seats that will be provided in the economy class, both for domestic and international flights (National Civil Aviation Agency, 2009). Compliance with the label is mandatory for airlines governed by the Brazilian Aeronautical Homologation Regulation 121 (RBHA 121) that have aircraft with a maximum takeoff weight exceeding 5,700 kg and more than 20 seats (DAC, 2005).

The label informs about the minimum distance between one seat and another, as shown in Figure 1, measured from a point 75 mm above the seat in the takeoff configuration (seat pitch), and classifies it into five categories (with "A" being the best and "E" being the worst):

"A": Minimum usable space between seats greater than 73 cm.

"B": Minimum usable space between seats less than or equal to 73 cm and greater than 71 cm.

"C": Minimum usable space between seats less than or equal to 71 cm and greater than 69 cm.

"D": Minimum usable space between seats less than or equal to 69 cm and greater than 67 cm.

"E": Minimum usable space between seats less than or equal to 67 cm.

Figure 1 - Seat Pitch Representation

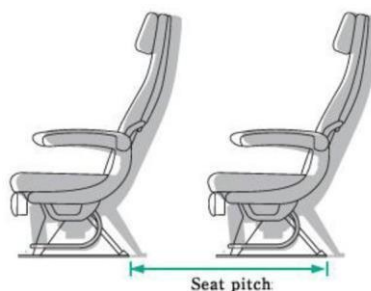

Source: (SKYTRAX, n.d.)

Figure 2 below, taken in July 2018, shows the seat pitch of seats on a LATAM Airlines commercial flight classified as "D" (minimum usable space between seats less than or equal to 69 cm and greater than 67 cm). As can be seen in the image, the passenger's legs in this situation touch the seat in front, underscoring the importance of an ergonomic study on aircraft seats to adapt them to the needs of all passengers and provide them with a safe and comfortable flight.

Figure 2 - LATAM Airlines Commercial Flight Seat

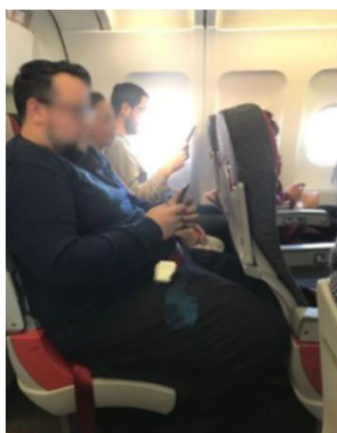

Source: (AUTHORS, 2018).

In this manner, with the aim of improving the quality of flights in economy class without increasing the aircraft's payload, reducing the number of seats, and still adhering to pre-established safety standards, an ergonomic study was conducted using the RULA method (RAPID UPPER LIMB ASSESSMENT). The objective was to design a seat that is suitable for human anatomy and, if possible, could bring economic and competitive advantages to the airline.

Mcatamney and Corlett (1993) were responsible for developing the RULA method, whose primary goal was to assess workers' exposure to risk factors related to musculoskeletal injuries during their activities (Dombidau Junior et al., 2017; Mateus Junior, 2009; Shida & Bento, 2012).

According to Shida and Bento (2012), the application of the method begins with the observation of the activity during several work cycles to identify the most relevant postures for analysis. By using body posture diagrams and scoring tables (Iida & Buarque, 2016), it becomes possible to assess the worker's exposure to risk factors. These risks are referred to as external load factors, namely (Dombidau Junnior et al., 2017): Number of movements; Static muscle work; Force; Working postures; Work duration without breaks.

The RULA method, therefore, aims to determine the need for intervention or further investigations carried out by experts concerning postures involving the neck and upper limbs of workers during their activities and the observed risks.

## **2. METHODOLOGY**

### **2.1 MARKET RESEARCH**

In order to better understand the severity of the issue addressed in this study, it was necessary to identify the key factors that interfere with the discomfort experienced by passengers during air travel. Thus, a market research was conducted.

The market research was created using the Google Docs Forms tool and distributed to the target audience through social media platforms, including Facebook and WhatsApp, over a period of 4 months, resulting in 442 responses.

When it comes to constructing a questionnaire, it is necessary to follow the following steps (Iida & Buarque, 2016): Establish the research objectives in order to define what is expected to be obtained from it. Define the most suitable method for collecting each type of information, whether multiple choice, rating scales, or open-ended questions. Define the target population. Determine the desired level of precision in the work in order to determine the size of the chosen sample.

Thus, for this study, the research questionnaire had the following objectives:

- a) Confirm the interest in the proposed solution.
- b) Identify the primary discomforts experienced during air travel.
- c) Establish a relationship between passengers' physiological characteristics and the discomforts experienced by them.

After defining the objectives, the market research was divided into 3 parts. The first part aimed to narrow down the responses to the target audience, ensuring that only responses from people who have traveled by plane were considered. This step consisted of a multiple-choice question where the user could choose between only two answers, "yes" (I have traveled by plane) or "no" (I have never traveled by plane).

In the second part of the research, the physiological characteristics of airplane seat users were evaluated. These characteristics included age, gender, weight, and height of the passenger.

The definition of gender was established through a multiple-choice question to avoid data inconsistencies. The response options for these questions were "female," "male," and "other." The "other" option was added to align with evolving societal standards, allowing freedom of expression.

To determine the age groups of users, an understanding of how human physiology changes with age was considered. Age groups were established where the human body undergoes minimal changes and were presented as multiple-choice options. Responses could be: "up to 13 years," "from 14 to 30 years," "from 31 to 50 years," and "above 50 years."

To determine users' weight, weight ranges were established to prevent embarrassment and false responses. The multiple-choice question allowed users to choose from 5 alternatives: "Less than 50 kgs," "From 51 to 65 kgs," "From 65 to 75 kgs," "From 75 to 85 kgs," and "More than 85 kgs." These weight ranges were chosen to investigate if flights are more uncomfortable for those with higher weights.

Next, to determine users' height, the same multiple-choice question format was used. Among the responses, participants could choose from 6 options: "Less than 1.50m," "Between 1.50 and 1.60m," "Between 1.61 and 1.70m," "Between 1.71 and 1.80m," "Between 1.81 and 1.90m," and "More than 1.90m." The aim of this question was to determine if, in addition to weight, the height of the user also influences the level of discomfort they experience during air travel.

After determining the physiology of the market research participants, questions directly related to the main issue of the study were asked, focusing on the discomfort felt by passengers.

In this third part of the research, users were first asked about the main discomforts they encountered during their travels. To avoid biasing their responses, this question also included answers that were not related to physical discomfort but rather other types of discomfort. The target audience could select 2 options from the 6 proposed ones, including: "Airfare prices," "Long wait lines for check-in and boarding," "Uncomfortable and cramped seats," "Baggage weight limit," "In-flight service," and "Limited space for carry-on luggage." The purpose of this question was to confirm interest in the proposed solution.

The following questions became increasingly specific. The two questions that followed aimed to identify whether travel time was a factor in exacerbating the pains and discomforts in question. The first question dealt with short trips of up to 3 hours, and the second with long trips (over 3 hours), with respondents asked whether they usually experienced pain after flights. Three responses were allowed: "yes," "no," and "sometimes."

If either of the two previous questions was answered with "yes" or "sometimes," the user received another question where they could indicate the parts of their body where they felt pain. These options included "Neck," "Legs," "Back," "Spine," "Arms," and "Other." Respondents could select as many options as they wished, and if they selected "Other," they were allowed to write in other body parts with pain. This expanded the response field and increased the users' ability to express themselves.

The last two questions of the field research were specific to the problem presented in this study and aimed to confirm interest in the proposed solution while defining the primary discomforts experienced during air travel. One of these questions allowed users to rate, on a scale of 1 to 5, how satisfied they were with the seats offered by airlines, with 1 being "very dissatisfied" and 5 being "very satisfied."

The last question of the market research allowed users to rate on a scale of 1 to 5 the level of discomfort due to each presented situation, which included "Limited space between your seat and the one in front of you," "Limited seat recline," "Seat hardness," and "Limited space in armrests." For this question, users considered 1 as "Does not bother me" and 5 as "Extremely bothered."

Before the survey was released to the target audience, it was tested with a smaller group of people, including teachers, close friends, and family members. After the test, some aspects of the survey were improved and corrected to make it clearer to those who responded.

To ensure that questionnaire responses are valuable and reliable, it is necessary to calculate the sample size. This is done using population size, margin of error, confidence level, and percentage value, as per Equation 1.

$$\frac{\frac{z^2 \times p(1-p)}{e^2}}{1 + \left(\frac{z^2 \times p(1-p)}{e^2 N}\right)}$$

Equation 1

N: Population size

e: Margin of error (decimal value)

z: Confidence level (z value)

p: Percentage value (decimal value)

To determine the required sample size for this research, we calculated, based on the desired level of uncertainty, the number of individuals who should participate in the survey to make it valid.

After determining the sample size, the questionnaire was shared in groups on social media platforms such as Facebook and WhatsApp.

## 2.2 RULA Simulation

The RULA method (Rapid Upper-Limb Assessment) assesses static muscle work and forces exerted by body segments, categorizing the level of action required for a particular movement. Level 1 indicates an acceptable posture, requiring no further investigation. Level 2 requires medium-term investigations. Level 3 necessitates immediate short-term investigations. The highest level, Level 4, requires immediate investigation and action (Iida & Buarque, 2016; McAtamney & Corlett, 2016).

To assess the potential inadequacy of airplane seats provided in the economy class, simulations were conducted using Dassault Systemes' software, known as 3D Experience. Within this software, the following applications were utilized: CATIA Bent Part Design, CATIA Ergonomics for Car Design, CATIA Human Design, and CATIA 3D Printing Preparation (Dassault Systèmes, n.d.).

In an effort to maintain simulation conditions close to reality, a model of an airplane seat similar to those currently used in economy class on commercial flights was sought. Using the GrabCAD Community, a 3D model sharing platform, the 3D seat design most closely resembling the real one, the Airbus A320 seat, was selected. In Brazil, this seat is used on 168 aircraft, belonging to airlines such as LATAM, Avianca, Brazil, and Azul. The 3D model file representing the A320 aircraft was provided by an engineer named Ali Hechi and had the dimensions shown in Figure 3.

Figure 3 - Selected 3D Model for Analysis

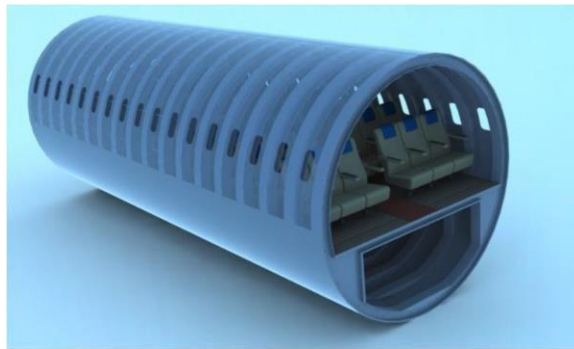

Source: (ELHECHI, 2013)

As can be observed in Figure 4 and Figure 5, the colors of the seat were altered to allow for better visualization of its parts and to achieve greater contrast when an avatar is positioned on it.

Figure 4 - Measurements of the studied chair model

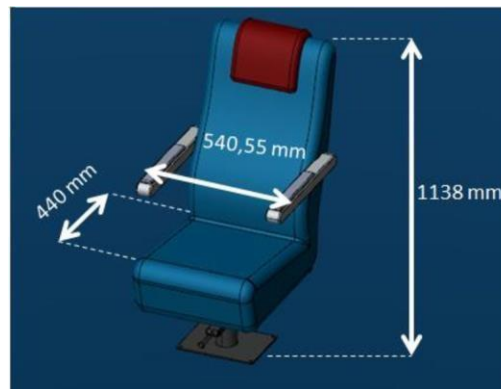

Source: (ELHECHI, 2013, modified)

Figure 5 - Measurement of a row consisting of 3 seats

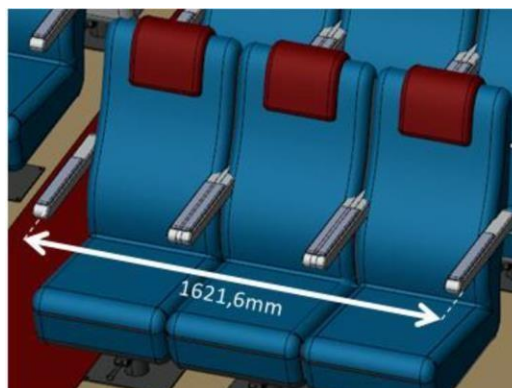

After selecting the seat model, study avatars were created. Using the CATIA Ergonomics for Car Design tool, six avatars with distinct physical characteristics were generated, as illustrated in Figure 6.

Figure 6 - Avatars selected for the study

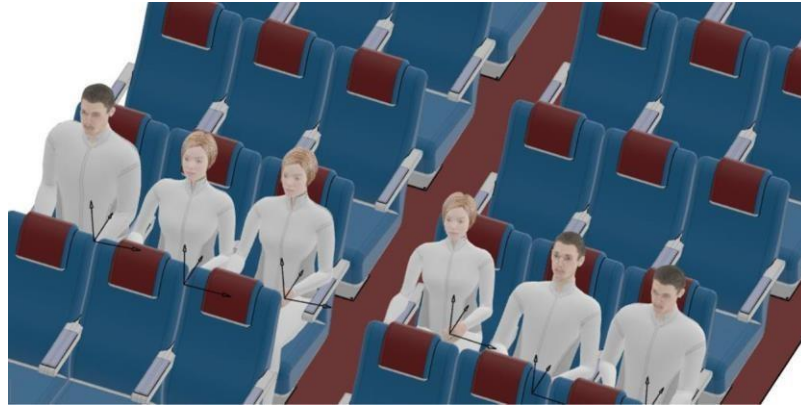

Source: (AUTHORS, 2018)

In order to reach a diverse portion of the population with this study, each created avatar represented a distinct segment of the population. The application of 3D Experience, CATIA Ergonomics for Car Design, allows users to select the nationality of the created human representation, as indicated in Figure 7. For this study, a 95% confidence level was used for all avatars created to represent a significant portion of the population.

The first avatar created (the one on the far left in Figure 6) was designed to represent the male American population. His height, specified by the CATIA Ergonomics for Car Design software, was 1.88 meters, and his weight was 119.36 kilograms. Next to him, the second avatar represents the female American population, measuring 1.73 meters and weighing 75.74 kilograms. Following that, a third avatar was created to represent the female population of France, with an average weight of 72.21 kilograms and a height of 1.72 meters.

On the other side, to the right of the aisle in Figure 6, three more avatars were created. The first of these was designed to represent the male German population, with an average weight of 97.24 kilograms and an average height of 1.85 meters. Next to him, a representative of the Japanese male population, weighing 79.35 kilograms and measuring 1.77 meters, is seated. Finally, next to the Japanese representative, an avatar was created to represent the female population of India. This last avatar was created with a weight of 63.75 kilograms and a height of 1.61 meters.



Figure 7 - Avatars in creation



Source: (AUTHORS, 2018)

After creating the avatars and importing the airplane seat model into CATIA, the CATIA Ergonomics for Car Design application was used to analyze and measure ergonomic issues involved.

Initially, the created mannequins were appropriately positioned in the seats, as indicated in Figure 6.

The report generated by the simulation, using the RULA analysis, allows for an examination of how each body part of the mannequin is affected by its position. It produces a score ranging from 1 to 9, representing the level of action to be taken, with options ranging from acceptance, investigation, future change, to immediate change of posture.

In this work, static RULA analysis was chosen, meaning it considered passengers staying in the same position during flights. Furthermore, it was assumed that passengers would not be holding any loads while seated, and their arms would be resting on the armrests.

The application used for generating the RULA analysis allowed for indicating whether the passenger was or wasn't resting their arms, thus providing more reliable results, as shown in Figure 8.

Figure 8 - Report generated by the RULA analysis

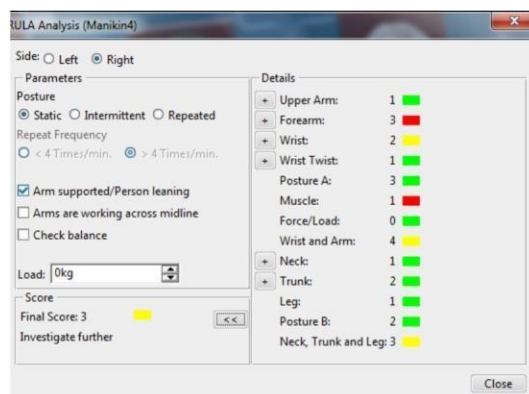

Source: (AUTHORS, 2018)

### 2.3 Creation Of The New Airplane Seat Model And Analysis Of Potential Changes To The Interior Aircraft Layout

After conducting the RULA analysis for all the created avatars, it became evident which body parts of the avatars were subject to greater discomfort when in the position dictated by the Airbus A320 seat.

Based on the results of the ergonomic analysis (which will be presented in the next chapter), an investigation into possible changes in the existing seat model was initiated to improve it and reduce the RULA analysis scores, making the passenger positions during flights more acceptable.

For this purpose, the 3D Experience application called CATIA Part Design (Figure 9) was used. With this tool, it was possible to make alterations to those parts of the seat believed to be causing more discomfort to passengers. After each change, a new RULA analysis report was applied to verify whether the altered parts indeed influenced the found scores.

Figure 9 - Using the Part Design application for the development of the new seat



Source: (AUTHORS, 2018)

After identifying the dimensions (width, height, and length) of the seat that had the most significant impact on passenger discomfort and therefore needed to be changed, the challenge was to make these alterations without changing the number of seats within the aircraft.

In this regard, it was necessary to modify the arrangement of seats, creating a new layout inside the aircraft. Firstly, the dimensions of the existing airplane seat and the seat-pitch used in the A320 aircraft arrangement were measured. Then, using geometric techniques such as the Pythagorean theorem and the theorem of similarity of triangles, it was possible to determine the available space for altering the seat dimensions. This led to obtaining the new dimensions for the seat and the new internal arrangement of the aircraft. Figure 10 represents the seating layout in the current model of the Airbus A320 aircraft.

Figure 10 - Current layout of the Airbus A320 aircraft

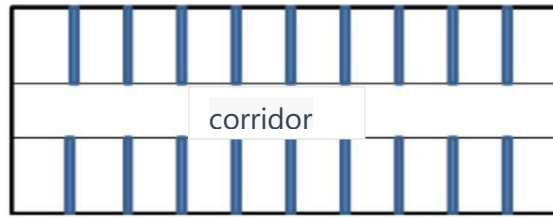

Source: (AUTHORS, 2018)

Additionally, as a basis for assisting in the ergonomic study and analysis, the Kroemer survey of anthropometric measurements and dimensions conducted for 15,700 men and 17,700 women in Germany was utilized. Comparisons with other studies have shown that the data obtained is quite similar for both sexes in Switzerland, England, the USA, and France. The relevant tables for the project used in the creation of the ideal seat can be found in Figure 11 and Figure 12.

Figure 11 – Anthropometric dimensions of the Kroemer survey

Measures (cm)	Women				Men			
	5%	50%	95%	D.P.	5%	50%	95%	D.P.
1 Standing body								
1.1 Structure, erect body	152,78	162,94	173,73	6,36	164,69	175,58	186,65	6,68
1.2 Eye height, standing	141,52	151,61	162,13	6,25	152,82	163,39	174,29	6,57
1.3 Shoulder height, standing	124,09	133,36	143,20	5,79	134,16	144,25	154,56	6,20
1.4 Elbow height, standing	92,63	99,79	107,40	4,48	99,52	107,25	115,28	4,81
1.5 Height of the center of the hand, standing	72,79	79,03	85,51	3,86	77,79	84,65	91,52	4,15
1.8 Depth of the chest	20,86	23,94	27,78	2,11	20,96	24,32	28,04	2,15
2 Sitting body								
2.1 Head height, sitting, from the seat	79,53	85,20	91,02	3,49	85,45	91,39	97,19	3,56
2.2 Eye height, sitting, from the seat	68,46	73,87	79,43	3,32	73,50	79,20	84,80	3,42
2.3 Shoulder height, sitting, from the seat	50,91	55,55	60,36	2,86	54,85	59,78	64,63	2,96
2.4 Elbow height, above the seat	17,57	22,05	26,44	2,68	18,41	23,06	27,37	2,72
2.6 Khee-khee length, sitting	54,21	58,89	63,98	2,96	56,90	61,64	66,74	2,99
2.9 Buttock- popliteal length, sitting	44,00	48,17	52,77	2,66	45,81	50,04	54,55	2,66
2.11 Height of the thighs, above the seat	14,04	15,89	18,02	1,21	14,86	16,82	18,99	1,26
2.13 Width of the hips, sitting	34,25	38,45	43,22	2,72	32,87	36,68	41,16	2,52
3 Head								
3.2 Head Width	13,66	14,44	15,27	0,49	14,31	15,17	16,08	0,54
3.3 Distance between eyes	5,99	6,23	6,85	0,36	5,88	6,47	7,10	0,37
3.4 Head circumference	52,25	54,62	57,05	1,46	54,77	56,77	59,35	1,54
4 Hands								
4.1 Length of the hand	16,50	18,05	19,69	0,97	17,87	19,38	21,06	0,98
4.2 Palm width	7,34	7,94	8,56	0,38	8,36	9,04	9,76	0,42
4.3 Palm Circumference	17,25	18,62	20,03	0,85	19,85	21,38	23,03	0,97
5 Feet								
5.1 Length of the foot	22,44	24,44	26,46	1,22	24,88	26,97	29,20	1,31
5.2 Foot width	8,16	8,97	9,78	0,49	9,23	10,06	10,95	0,53
7 Weight (KG)	39,2 *	62,01	84,8*	13,8*	57,7*	78,49	99,3*	12,6*

Source: (Kroemer et al., 2000)

Figure 12 – Anthropometric dimensions data

Greatness	Men ( mm) Average - 90%		Women (mm) Average - 90%	
Leg length	450	420 - 480	430	400 - 460
Thigh length	500	460 - 540	460	430 - 500
Distance between elbow and seat base	240	200 - 280	240	200 - 280
Forearm length	470	430 - 510	420	380 - 460
Distance between the shoulder and the seat base	590	540 - 640	540	490 - 590
Distance between the top of the head and the base of the seat	900	840 - 960	850	790 - 910
Leg length up to above the knee	550	510 - 590	500	460 - 540
Shoulder width	435	--	412	--
Width of the pelvis	340	--	343	--

Source: (Kroemer et al., 2000)

Considering the dimensions presented in the tables above, it was possible to validate whether the measurements of the new airplane seat model were suitable for the human body's anatomy.

### 3. RESULTS AND DISCUSSIONS

#### 3.1 MARKET RESEARCH RESULTS

According to the data from the Air Transport Yearbook conducted by the National Civil Aviation Agency (ANAC) in 2016, the number of passengers transported in domestic flights in Brazil in 2016 was 109.6 million. In this way, this value was used as the population size for calculating the sample size.

The margin of error, or sampling error, represents the maximum estimate of errors in a survey. Therefore, the higher the precision required by the research, the smaller the chosen error rate should be for sample size calculation. The commonly established margin of error is 5%, with a confidence interval (CI) of 95%, which sets the z-value at 1.96. The commonly used percentage value is 0.5 (50%).

Using the formula indicated in Equation 1, presented in the previous chapter, it was possible to calculate that 385 responses would be required for the market research to be used as a reliable source, and this number was established as the target by the group.

The target was successfully achieved as the market research, which was promoted on all social media platforms, obtained 442 responses.

The first question, "Do you usually travel or have you ever traveled by plane?" was answered by 442 people, of whom 437 (98.9%) responded that they had traveled in this way, meaning only 5 of the respondents (1.1%) had never had this experience. The following question aimed to determine the gender of the respondents, with the vast majority, 77.4%, identifying as female, while only 22.6% identified as male.

Of the survey participants, 275 (62%) stated they were in the age range of 14 to 30 years, 72 (16.3%) claimed to be between 31 and 50 years old, and 95 (21.5%) reported being over 50 years old. There was also an option for "up to 13 years," which was not chosen by any of the respondents.

Regarding the weight of the users, the responses were well-distributed across the various pre-established weight categories. Among the respondents, 34 (7.7%) declared they weighed less than 50 kg, while a significant number of 164 (37.1%) said their weight fell in the range of 51 kg to 65 kg. Furthermore, 118 people (26.7%) reported a weight of 75 kg to 85 kg, and finally, 57 (12.9%) of the respondents stated their weight exceeded 85 kg.

The final physiological question about the users requested information about their height. Among the respondents, 108 people (24.4%) selected the option between 1.50 m and 1.60 m, and nearly half of the participants, 199 (45%), declared a height of 1.61 m to 1.70 m. The option for the range of 1.71 m to 1.80 m was chosen by 98 people (22.2%). Additionally, 29 users (6.6%) reported heights between 1.81 m and 1.90 m, and finally, only 7 respondents (1.6%) had a height exceeding 1.90 m.

Regarding the question about the main discomforts encountered during airplane trips, as expected, the most voted option was "uncomfortable and cramped seats," with 82% of the votes, followed by the "airfare price," chosen by 70% of the total respondents.

Still, in relation to the same question, the option of "baggage weight limit" was voted on by 24.1% of the travelers, ranking third. The other less voted options were: "in-flight service (service, food)," chosen by 10% of the voters; "long queues for check-in and boarding," voted by 9.8% of the respondents, and "limited overhead bin space" chosen by only 7.3% of the users.

Thus, with the responses obtained from this question, it was possible to confirm that the seats currently used by airlines are not completely satisfying their customers, who find them uncomfortable and cramped.

Regarding the question "Do you usually experience pain after short flights (up to 3 hours)?" 54.1% of the travelers responded that they did not, while 29.6% said they sometimes experienced pain, and 16.3% reported experiencing pain on short flights.

However, on long flights (over 3 hours), the values changed significantly: 64.3% of the respondents stated they experienced pain; 25.6% believed this discomfort occurred sometimes, and only 10.2% claimed not to experience pain after long airplane trips. These numbers reflect the number of users who experience pain when using current seats and the importance of seeking new ergonomically correct solutions.

Subsequently, those who answered "yes" to the previous questions were asked which parts of their bodies they usually felt pain in, with the option to select more than one option. The majority of users reported pain in their "back" (50.5%), "neck" (48.4%), "legs" (44.1%), and "spine" (41.9%). Some travelers also opted for options such as pain in the "arms" (1.6%), "knees" (1.1%), and "lower back" (0.7%). Finally, there were users who included new options such as "tailbone," "shoulder," "buttocks," "ear," and "ankle."

The following questions allowed users to select a number from 1 (very dissatisfied) to 5 (very satisfied). The first of them directly asked the users how satisfied they are with the seats currently offered by airlines in the economy class. The responses are described in Figure 13:

Figura 13 – User satisfaction level

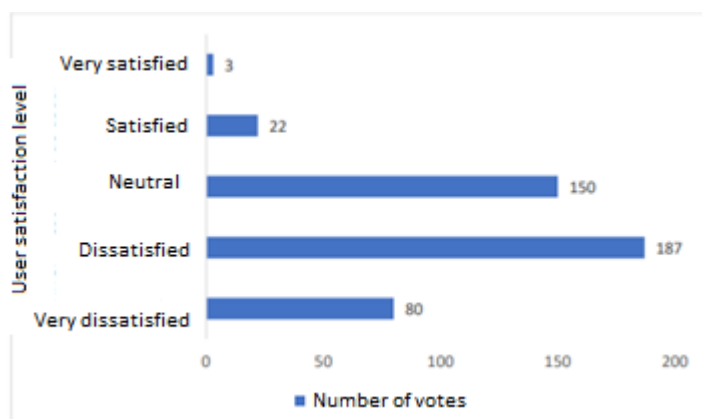

Source: (AUTHORS, 2018)



Figure 14: presents the results obtained for user discomfort levels.

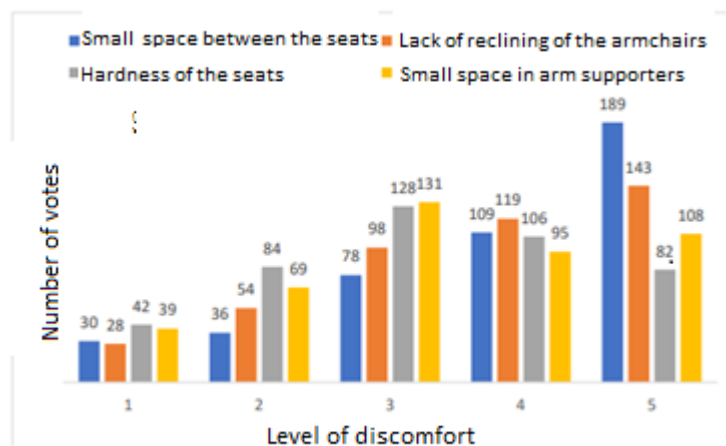

Source: (AUTHORS, 2018)

Regarding the variable "Small space between your seat and the one in front of you," the number of voters increases at each discomfort level.

Concerning the variable "Limited seat recline," the responses followed the same pattern as the previous question, with few votes in the options representing low discomfort and a higher number of votes in the options indicating high discomfort.

When asked about the "Hardness of the seats," users responded differently, with the majority concentrating in the discomfort levels 2, 3, and 4, as shown in Figure 1.

Finally, travelers rated how bothered they are about the "Limited space in the armrests of the chairs," with level 3 being the most common.

With the travelers' responses regarding each of these characteristics, a weighted average of the variables was calculated to determine which one is the most critical. The calculation was performed by assigning a weight of 1 for the "I don't mind" situation and a weight of 5 for the "Extremely bothered" situation (Table 1).

Table 1 - Criticality of Variables

condition	criticality
-----------	-------------



A small space between the seats	114,5
Limited seat recline	108,1
Hardness of the seat	95,2
Limited space in the armrests	99,3

Source: (AUTHORS, 2018)

Therefore, it was possible to understand that the variables related to airplane seats (currently used in the economy class of aircraft) that cause the most discomfort to passengers, in ascending order, are the limited space between the seats in front, followed by the limited recline of the seat, the limited space for armrests, and lastly, the hardness of the seats.

### 3.2 Results Of Rula Simulations

After conducting simulations in the 3D Experience Ergonomics for Car Design software, a RULA analysis report was generated for each digital manikin used. Remember that the RULA analysis scale ranges from 1 to 9.

The average American male studied yielded a RULA analysis score of 5 points, indicating that the seat was inadequate for a man of his size and should be changed soon. The parts of the male avatar most affected by the seat position in the airplane were his forearms, arms, shoulders, and legs.

Upon analyzing the simulation, it was observed that the narrow distance between armrests was largely responsible for the discomfort experienced in the arms and shoulders of the man. With the armrest distance of 480 mm, as seen in the seats currently used in the Airbus A320, the average American passenger is forced to hunch their shoulders and twist their arms in an improper manner (Figure 15).

Figure 15 - Simulation with American Male Avatar

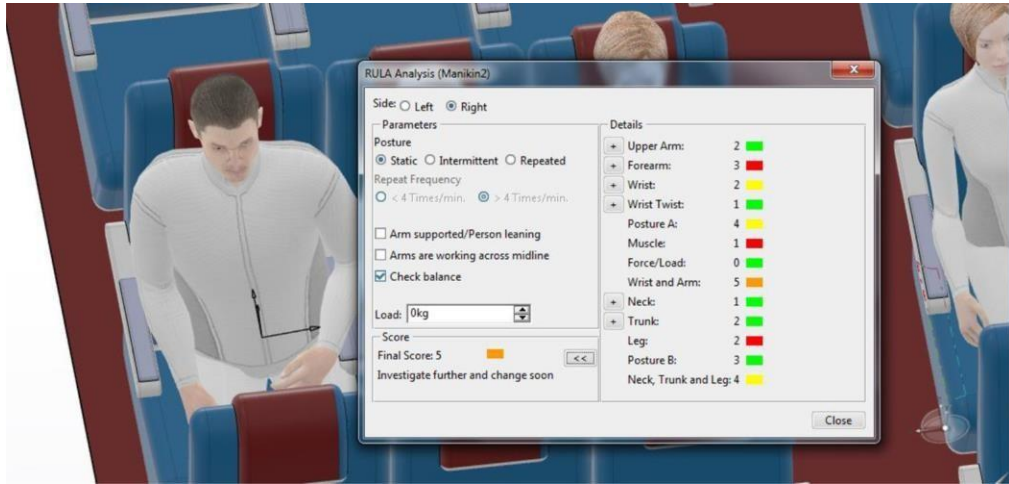

Source: (AUTHORS, 2018)

In the second simulation, conducted with the average American female manikin, the result obtained in the RULA analysis was a score of 4. Through the analysis, it was observed that the body parts that experienced the most discomfort were the legs and the posterior arm muscles of the avatar. Given that this manikin is smaller than the one presented previously, the RULA analysis generated a lower score.

However, the fact that the avatar was sitting next to a larger-sized avatar caused her to hunch her right shoulder and legs, which in turn affected these parts of her body, as demonstrated in Figure 16.

Figure 16 - Simulation with American Female Avatar

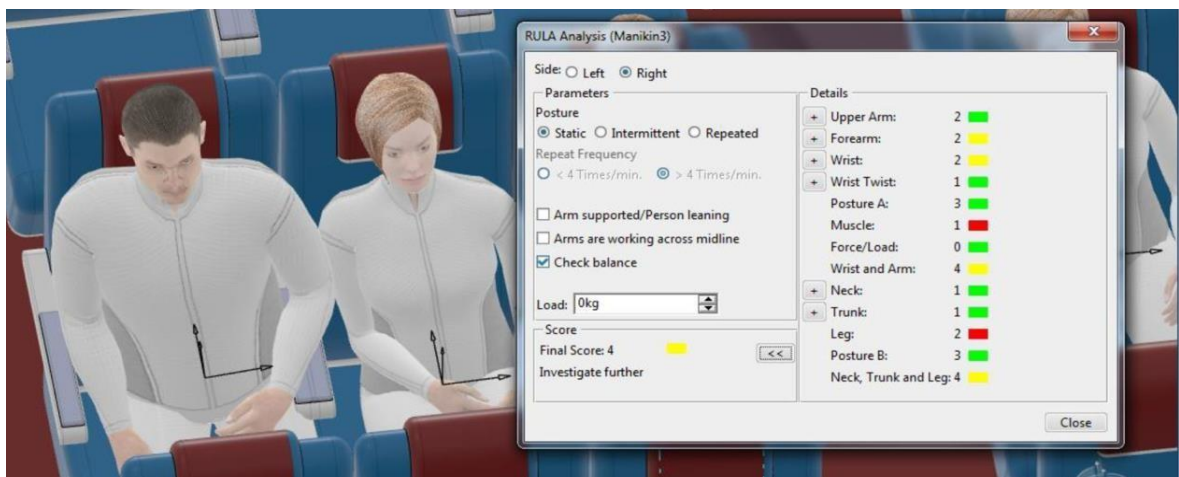

Source: (AUTHORS, 2018)

The next manikin analyzed, of French nationality and female gender, scored 3 points in the RULA analysis, also indicating the need for investigation into the seat in question. Since the seat next to this avatar was occupied by another avatar of a smaller size, the first avatar had greater mobility in supporting her arms, which resulted in a lower RULA analysis score, as indicated in Figure 17.

Figure 17 - Simulation with French Female Avatar

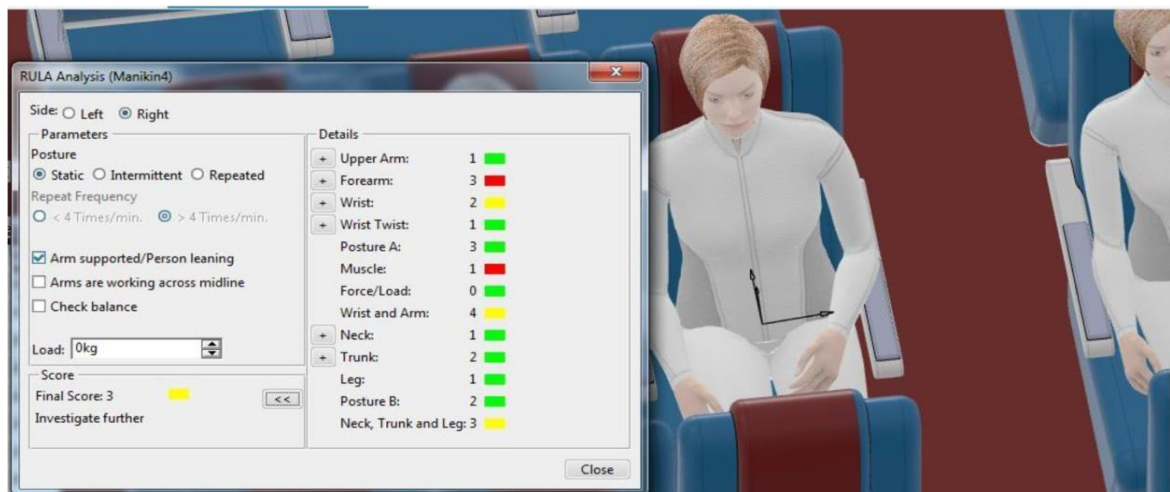

Source: (AUTHORS, 2018)

The RULA analysis conducted on the female manikin of Indian nationality resulted in a score of 4 points, further emphasizing the need to investigate the causes of poor posture provided by the seat under study. The body parts of this avatar at greater risk of musculoskeletal discomfort in this case were the forearms, posterior arm muscles, and legs. From the analysis of the results, it can be observed that the seat in which the Indian manikin is sitting in Figure 18 is too narrow for her.

Figure 18 - Simulation with Indian Female Avatar

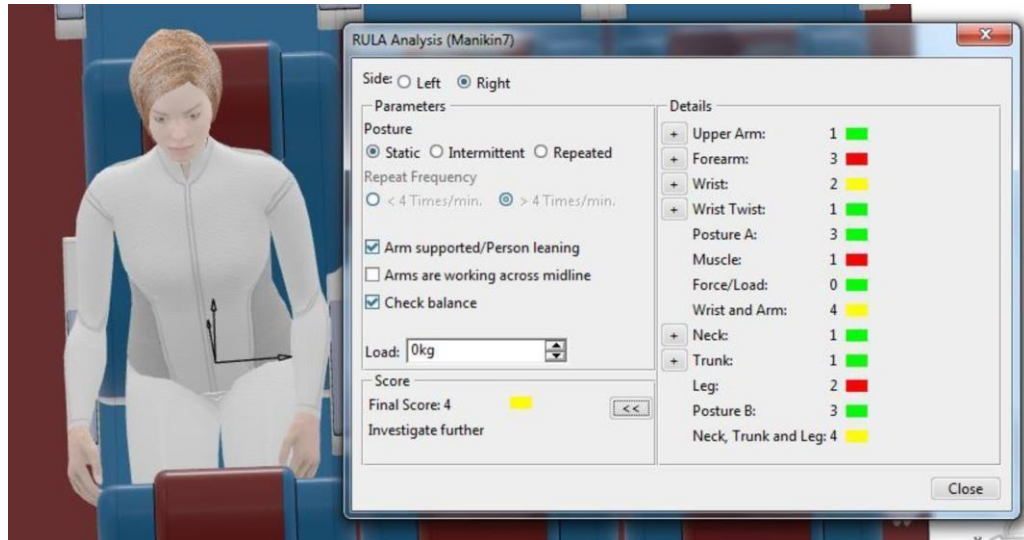

Source: (AUTHORS, 2018)

The following analysis was conducted on a male Japanese manikin (Figure 19). The RULA analysis performed on this manikin indicated a level 4 risk, just like in the previously described manikin.

Because a Japanese man is, on average, smaller than an American man, the score generated in the RULA analysis in this simulation was lower. However, the most affected body parts in both cases were the same.

Figure 19 - Simulation with Japanese Male Avatar

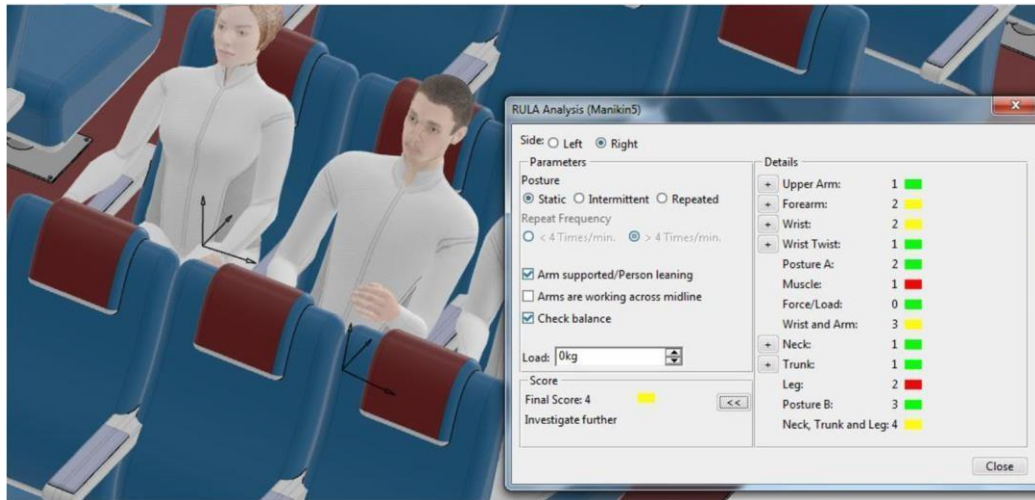

Source: (AUTHORS, 2018)

Finally, the ergonomic study conducted on the German male manikin resulted in a score of 4 in the RULA analysis.

Unlike the Japanese mannequin presented earlier, the German mannequin under study had to twist its arms and wrists inappropriately to fit into the airplane seat, as shown in Figure 20. This is due to its taller stature and the need for it to shrink in order to rest its arms on the side armrests.

Figure 20 - Simulation of a male German avatar

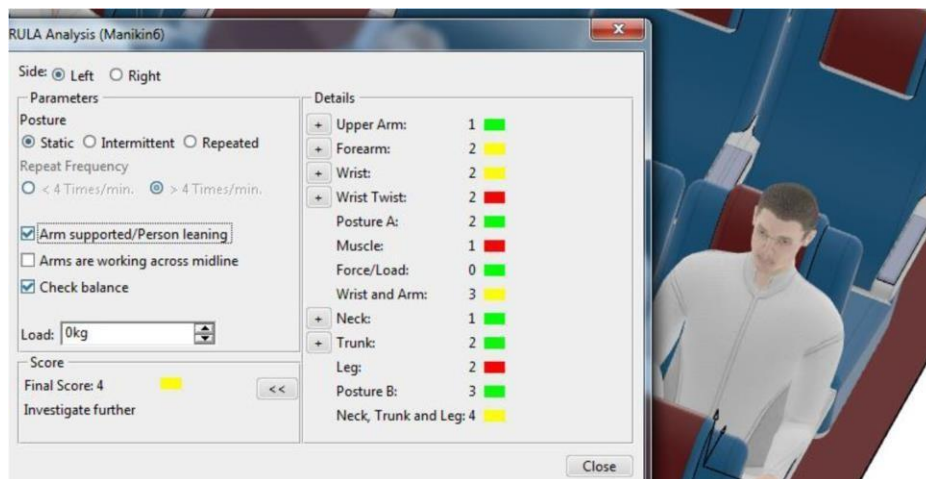

Source: (AUTHORS, 2018)

After conducting the RULA analysis on the six avatars described above, it became evident that the seats currently used in Airbus A320 airplanes needed to be investigated and potentially modified soon to accommodate all or the majority of their users.

Furthermore, it was observed that larger avatars, such as the American and the German, experienced greater discomfort during the simulations compared to the others. The study conducted on these six avatars also allowed researchers in this field to identify the primary reasons why the mannequin's limbs were affected during the simulations. After examining all the simulations, it was concluded that the main cause of discomfort was the narrow width of the seat, which forced passengers to hunch their shoulders and legs to fit into the airplane seat.

Table 2 - RULA Simulation Results

<b>nationality</b>	<b>gender</b>	<b>RULA Method Result</b>
American	Masculine	5
American	Feminine	4
French	Feminine	3
Indian	Feminine	4
Japonesese	Masculine	4
German	Masculine	4

Source: (AUTHORS, 2018)

### 3.3 Results Of The New Seat Model And Aircraft Layout

After conducting the RULA simulations presented earlier, it was possible to determine that the width of the studied airplane seat was inadequate for almost all the avatars analyzed. It was also noticed that increasing this dimension significantly reduced the RULA score, making it clear that a change in this measurement was necessary.

In order to determine by how much the width of the seat could be increased, the following analyses and calculations were performed:

The layout of the Airbus A320 consists of rows arranged horizontally, with two blocks of rows separated by an aisle between them. Each row consists of three seats side by side, and the total length of a row (considering the three seats and their respective armrests) is 1,621.65mm, while the seat pitch (the distance between one seat and the seat in front) measures 1,000.00mm, as shown in Figure 10.

It was observed that if the rows were arranged diagonally, the total length of a row could be greater (the value of the diagonal), which would allow for an increase in the width of each seat and a significant ergonomic improvement, according to the studied simulations. Figure 21 illustrates the geometric study conducted to determine the available space for relocating the seats in a way that would keep the width of the aisle the same, so as not to hinder the passage of passengers and the meal cart.

Figure 21 - New Arrangement of Seat Rows in the Aircraft

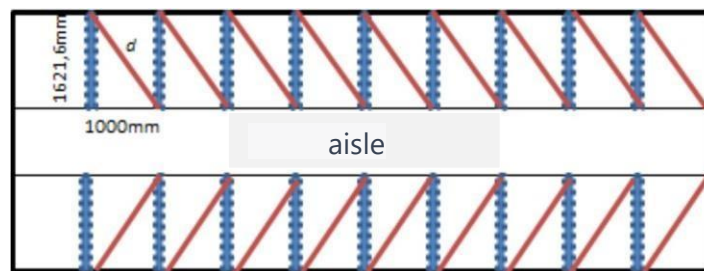

Source: (AUTHORS, 2018)

Based on the results shown above, the new width and the new seat pitch for the developing seat were determined. The value of the found distance "d," which was 1905.19 mm, allowed for the allocation of 3 seats, each with a width of 635.06 mm, considering the armrests. Therefore, the new seat now has almost 100 mm more width than the previous one, which measured 540.55 mm in width. Additionally, the new seat pitch value of 851.12 mm still falls within Class A of seat pitch established by ANAC (values greater than 730 mm).

After making the necessary changes to the Airbus A320 airplane seat to reduce the risks identified in the RULA simulations presented earlier, the following seat model was obtained, as indicated in Figure 22 and Figure 23.

Figure 22 - Measurements of the New Seat



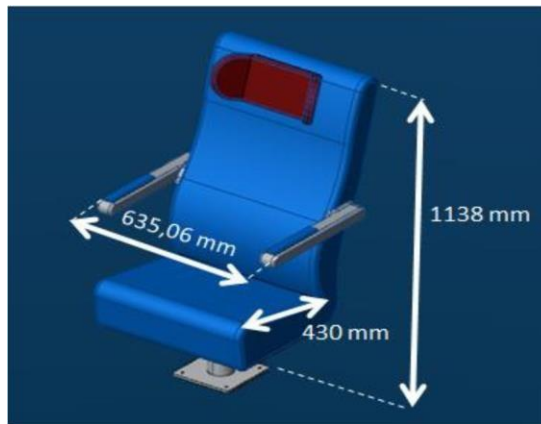

Source: (AUTHORS, 2018)

Figure 23 - Measurements of a New Row

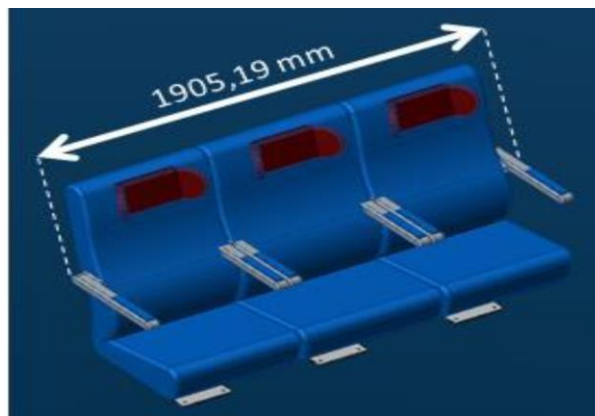

Source: (AUTHORS, 2018)

With the new layout, it was possible to increase the seat width by 94.51 mm, with 50 mm added to the cushion and the remainder used to insert individual armrests to avoid sharing them, as in the previous model. This change increased the passenger's internal seating space by a little over 10% of its old dimension. This change resolved a significant portion of the discomfort caused by the old seat, as passengers no longer need to hunch their shoulders and legs to fit into the seat.

According to the Kroemer Table shown in Figure 28, the maximum values found in the sample study for hip width with the body seated, meeting the 95th percentile of women, were in the range of 459.40 mm. Additionally, the average shoulder width



found in the study was 435.00 mm. Therefore, the new seat is in line with this analysis and promises to provide more space and comfort for travelers.

Another important factor considered during the development of the new seat was the seat height, as the correct sitting position requires feet to be fully supported on a surface, and it's important that the seat height is the same distance from your knee to the floor (Dul & Weerdmeester, 2012). Furthermore, leaning the lower back forward in an attempt to place the feet on the ground can be extremely detrimental to health.

Thus, to prevent shorter individuals from having their legs "dangling" in the air, the seat height should be designed considering the shortest leg length, which corresponds, according to Kroemer's analysis, to 400mm. The seat height measurement of the old seat already met this requirement, which remained unchanged for the new seat.

In addition, in terms of seat length, the correct measurement should represent the shortest value found for thigh length to avoid pressure on the lower part of it. Adequate dimensions to accommodate buttocks and thighs should leave only the knee protruding (Iida & Buarque, 2016). The value indicated in the study was 430 mm, which was adopted for the length of the new seat (ROEBUCK, J. A. Jr.; KROEMER, K. H. E.; THOMSON, 1975).

Finally, a side headrest support was added, serving as a cushion, increasing passenger comfort when reclining to the sides and minimizing potential neck and spine discomfort during long flights.

The new arrangement of seats within the aircraft can be observed in Figure 24 and Figure 25. It can be noted that in the last row, only two seats fit on each side. To maintain the same number of seats within the aircraft, the remaining seats were inserted, one on each side, at the front of the plane.

Figure 24 - New Seat Arrangement - Top View

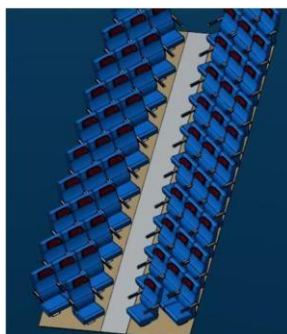

Source: (AUTHORS, 2018)

Figure 25 - New Seat Arrangement - Side View



Source: (AUTHORS, 2018)

The results of the simulations conducted with the six digital mannequins using the new seat and aircraft layout will be presented in the same manner as they were previously carried out with the Airbus A320 seat model, in order to visualize the changes and potential ergonomic improvements gained. Figure 26 illustrates the positioning of the mannequins in the new seat.

Figure 26 - Avatars Positioned in the New Airplane Seats

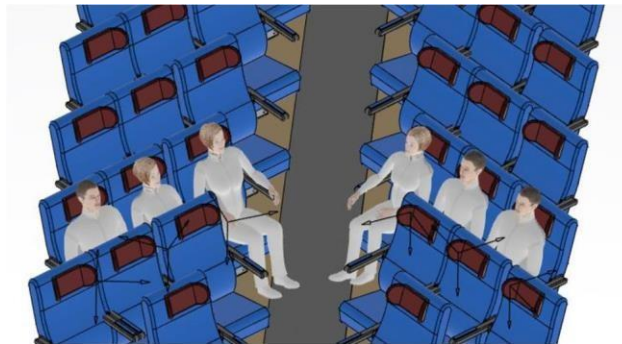

Source: (AUTHORS, 2018)

The first mannequin analyzed was the American male, which previously had a RULA ergonomic analysis score of 5, indicating an extreme need for change. Using the new seat, the analysis returned a score of 3 for this avatar, indicating a significant ergonomic improvement, although there are still a few points of concern. The factor that contributed most to this improvement was the increased distance between the armrests of the seat, allowing the avatar greater mobility so that he didn't have to hunch his arms and shoulders while sitting. Figure 27 shows the results obtained in this new simulation.

Figure 27 - Simulation with American Male Avatar in the New Seat

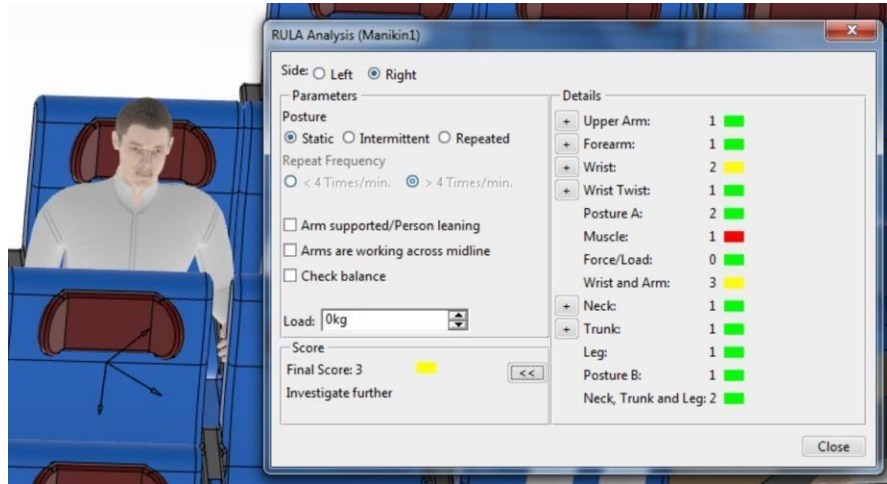

Source: (AUTHORS, 2018)

The second mannequin analyzed was of American nationality, female gender (Figure 28), which obtained a score of 4 in the ergonomic analysis of the old armchair. This score was reduced to 3 with the use of the new seat, demonstrating acceptable conditions for individuals of this physical type, although there are still some points of concern.

In the initial analysis conducted with this avatar, it was observed that the main issue was located in the legs and the posterior arm muscles because it was seated next to a larger-sized avatar (an American male described earlier). This required the avatar to shrink its shoulders and legs. With the increase in the width of the armchair, the avatar gained sufficient space to support its limbs properly without being influenced by the physical type of the avatars nearby, which explains the improvement achieved.

Figure 28 - Simulation with a female American avatar in the new armchair

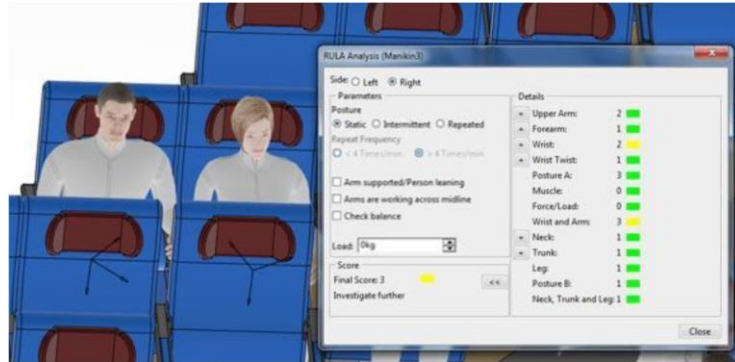

Source: (AUTHORS, 2018)

Next, the RULA analysis was performed on the French female mannequin (Figure 29). The simulation on this mannequin resulted in a score of 2 on the RULA scale, indicating that the position of this avatar in the new seat is in acceptable conditions for this physical type.

In the previous simulation conducted with this mannequin, the RULA result had generated a score of 3, indicating the need for further investigation of the seat.

Figure 29 - Simulation with a female French avatar in the new armchair



Source: (AUTHORS, 2018)

The next mannequin analyzed was of Indian nationality, female gender, which had also obtained a score of 4 in the analysis of the old armchair. As indicated in Figure 30, the result generated using the new armchair was 2, with all limbs in acceptable ergonomic conditions, except for the forearm, which still has some points that need improvement. This result once again confirms how the changes in the new seat have indeed contributed to the ergonomic improvement.

Figure 30 - Simulation with a female Indian avatar in the new armchair

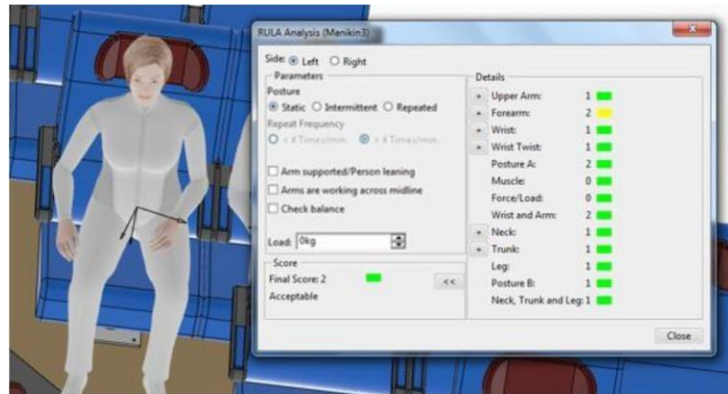

Source: (AUTHORS, 2018)

Subsequently, the analysis was performed on a male Japanese mannequin. The RULA analysis conducted on this mannequin had indicated a level 4 score, and in the current analysis, as shown in Figure 31, the result improved to level 2, with only the forearm and wrist showing areas for potential improvement, while the other limbs were in acceptable ergonomic conditions.

Figure 31 - Simulation with a male Japanese avatar in the new armchair

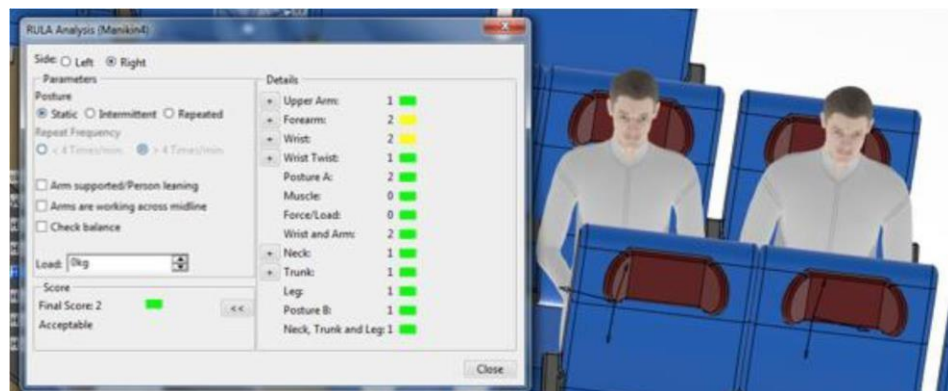

Source: (AUTHORS, 2018)

The last simulation was conducted on a male mannequin of German nationality, which had previously obtained a level 4 score and became level 3 in the analysis of the new armchair. The result obtained was quite similar to that of the American avatar since both have similar large-sized physical types. Figure 32 presents the results of this simulation.

Figure 32 - Simulation with a male German avatar in the new armchair

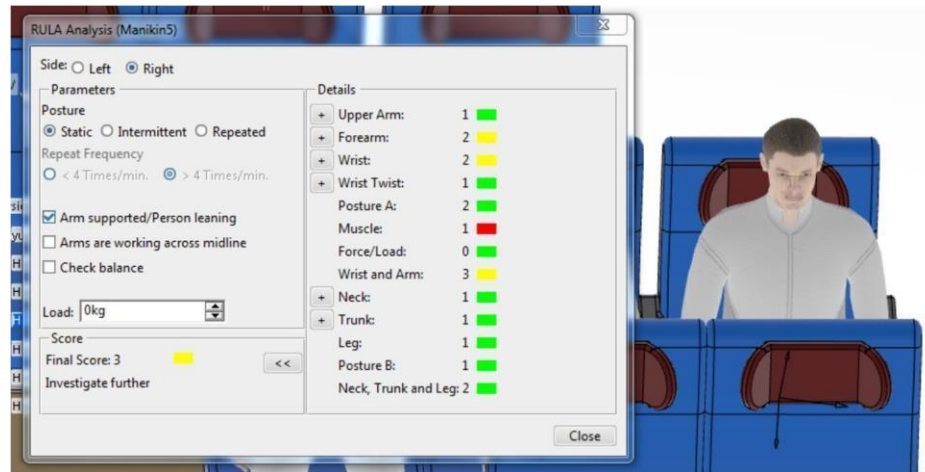

Source: (AUTHORS, 2018)

After conducting all the simulations in the new airplane seat using different avatars and comparing them with the results obtained previously with the old seat, it was observed that in all cases, there was an improvement in the ergonomic result, as expected. Table 3 allows you to compare the values obtained in the simulations of the two analyzed seats.

Table 3 - Comparison of RULA analysis results from simulations conducted on the two chair models

Nacionality	Gender	Armchais Airbus A320	Designed Armchair
American	Masculine	5	3
American	Feminine	4	3
French	Feminine	3	2
Indian	Feminine	4	2
Japonesse	Masculine	4	2
German	Masculine	4	3

Source: (AUTHORS, 2018)

Only in the results for the larger-sized avatars, the American man, German man, and American woman, despite showing improvements, there are still some areas of concern. This is because, due to their larger dimensions, their limbs continue to be affected more intensely than the other analyzed mannequins.

Another notable aspect is that in ergonomics, small changes can lead to significant improvements in results. The airplane seat was an example of this, as these positive results were achieved through small alterations made to certain dimensions of the Airbus A320 seat.

#### **4. Conclusion**

This study aimed to develop an ergonomic analysis of the standard seat currently used in commercial aircraft in the economy class. The goal was to understand the main causes of discomfort experienced by passengers and design a new seat model that better meets the needs of users, providing comfort and safety during flights.

The hypothesis that the current seat model is not ergonomically suitable for travelers was strengthened by market research, which showed dissatisfaction among a significant portion of passengers. This hypothesis was further confirmed by the ergonomic analysis conducted using the 3D Experience CATIA Ergonomics for Car Design software, which involved six mannequins of different nationalities and physiognomies. This analysis revealed the need for an investigation into the Airbus A320 seat and potential future changes. Thus, it can be concluded that the primary objective of this study was successfully achieved.

The changes made to the aircraft layout, with seats arranged diagonally instead of horizontally, allowed for an increase of 94 mm in the width of each individual seat. This modification brought various ergonomic improvements to the seat when compared to its previous model, according to the new simulations carried out in the 3D Experience CATIA Ergonomics for Car Design software.

Furthermore, the key dimensions of the new seat (height, length, and width) were explored and tested in conjunction with Kroemer's anthropometric dimensions table, confirming that the seat's measurements are indeed in accordance with human anatomy.

Due to a lack of information and conditions for manufacturing the new seat in full size, it was not possible to address and study the issue of weight reduction for potential cost savings for airlines (secondary objective).



However, given the importance of the subject and the aim to continuously improve safety, comfort, and well-being for passengers during their travels, further research is needed into the seats of other aircraft provided by airlines.

As a proposal for future work, there is the possibility of conducting a feasibility study of the new seat arrangement in relation to aviation regulations, as well as conducting market research to assess passenger acceptance of the suggested layout. This would help identify other possible improvements in the object of study.

## 5. References

Agência Nacional de Aviação Civil. (2009). Programa Selo De Avaliação Dimensional: Selo Anac.

Casagrande, V. (2018). Aérea poupa R\$ 10 mi em combustível com menos vinho a bordo e revista leve. Todos a Bordo. <https://todosabordo.blogosfera.uol.com.br/2018/02/04/aerea-economia-combustivel-menos-vinho-revista-leve/>

DAC. (2005). RBHA 121 Requisitos Operacionais : Operações Domésticas , De Bandeira E Suplementares Este Arquivo Contém O Texto Do Rbha 121 , Aprovado Pela Portaria No 483 / Dgac De 20 De Março De 2003 , Publicada No Dou No 76 , De 22 De Abril De 2003 , Incluindo Tod.

Dassault Systèmes. (n.d.). The 3DEXPERIENCE platform, a Game Changer for Business and Innovation. Retrieved March 13, 2021, from <https://www.3ds.com/3dexperience>

Dombidau Junnior, R. C., Silva, B. C. B. da, & Canedo, G. R. (2017). Aplicação Do Método Rula (Rapid Upper Limb Assessment) Em Um Laboratório Didático. Xxxvii Encontro Nacional De Engenharia De Producao. [http://www.abepro.org.br/biblioteca/TN\\_STO\\_241\\_401\\_32996.pdf](http://www.abepro.org.br/biblioteca/TN_STO_241_401_32996.pdf)

Dul, J., & Weerdmeester, B. (2012). Ergonomia Prática (3rd ed.). Blucher.

ELHECHI, A. (2013, January 30). Airbus A320 | 3D CAD Model Library | . GrabCAD. <https://grabcad.com/library/airbus-a320--2>

Iida, I., & Buarque, L. (2016). Ergonomia: Projetos e Produção. In Blucher. Blucher. Kroemer, K. H. E., Kroemer, H. B., & Kroemer-Elbert, K. E. (2000). Ergonomics: How to

Design for Ease and Efficiency. Pearso.



- Mateus Junior, J. R. (2009). Diretrizes Para Uso Das Ferramentas De Avaliação De Carga Física De Trabalho Em Ergonomia: Equação Niosh E Protocolo Rula [Universidade Federal de Santa Catarina ]. <https://repositorio.ufsc.br/xmlui/bitstream/handle/123456789/92479/264521.pdf?sequence=1&isAllowed=y>
- McAtamney, L., & Corlett, E. N. (1993). RULA: a survey method for the investigation of work-related upper limb disorders. *Applied Ergonomics*, 24(2), 91–99.
- McAtamney, L., & Corlett, N. (2016). Avaliação rápida dos membros superiores (RULA). In
- N. Stanton, A. Hedge, K. Brookhuis, E. Salas, & H. Hendrick (Eds.), *Manual de Fatores Humanos e Métodos Ergonômicos* (pp. 73–83). Phorte.
- ROEBUCK, J. A. Jr.; KROEMER, K. H. E.; THOMSON, W. G. (1975). *Engineering anthropometry methods*. John Wiley.
- Rosenbloom, S. (2016). Fighting the Incredible Shrinking Airline Seat. *The New York Times*. <https://www.nytimes.com/2016/02/29/travel/shrinking-airline-seats.html>
- Shida, G. J., & Bento, P. E. G. (2012). Métodos e ferramentas ergonômicas que auxiliam na análise de situações de trabalho. VIII Congresso Nacional De Excelência Em Gestão.
- SKYTRAX. (n.d.). Airline Seat Pitch Guide. Retrieved June 1, 2020, from <https://www.airlinequality.com/info/seat-pitch-guide/>
- Vinholes, T. (2018, January 18). Boeing forma nova empresa para fabricar assentos de avião. *Airway*. <https://www.airway.com.br/boeing-forma-nova-empresa-para-fabricar-assentos-de-aviao/>