

The use of system concurrent engineering to develop a configuration system for automobile interior

Thiago Duarte Pereira, Marcos Flávio de Souza Reis, Geilson Loureiro

National Institute for Space Research

e-mails: thiago@dea.inpe.br; marcosfsreis@gmail.com; geilson@lit.inpe.br

Abstract: In recent years, the use of the System Concurrent Engineering methodology, developed by (LOUREIRO, 1999), is gaining visibility in the development of complex products, mainly in the automotive, aeronautical and space sectors. The main goals of this methodology are the integration of development organization with the processes of the product life cycle and the concurrent management of the requirements in the early phases of development. Thus, this methodology was used to develop an automobile interior configuration system and it was able to increase the viability, planning, development and organization during its life cycle. The system is classified as a complex product due to the large number of physical and functional parts and the large number of multidisciplinary areas responsible for its development. The application of this methodology increases controllability in the management of complex products development. For that end, this paper presents a brief description of the goals of this system and the stages of the applied development process depending on the methodology of (LOUREIRO, 1999).

Keywords: system engineering, concurrent engineering, automotive industry, product development.

1. Introduction

Two important factors that make a difference in market competition in the automotive industry are comfort and safety. Nowadays, new technologies are being developed with the purpose of providing ease and satisfaction in the use of automobiles. Thus, something that today is feasible and is already being developed in some vehicles is a system that is able to configure devices and to provide information about its maintenance status. A system with these features, called Configuration System of Automobile Interior was developed with the aid of the (LOUREIRO, 1999) methodology. Its stages and development processes will be presented in this paper.

The methodology differs of the traditional Systems Engineering because the Concurrent Engineering is included during the development process. The objective of Concurrent Engineering is to anticipate requirements from life cycle processes to the early stages of development. Various problems and risks are identified at the start of the development process. Therefore, security measures are defined to avoid those problems in later stages.

The system's mission is to configure the following devices: air conditioning; seats height; inclination and rearview mirror and steering wheel angular position adjustment. The system will act upon those devices depending on the user's profile. Each user must be registered and his profile will be stored in the system memory. The

system also displays information about the current state of the automobile: information about the tires calibration; how much fuel is necessary to arrive at the destination (information linked to the automobile GPS); alert signal to inform when the safety belts are not being used and doors are not locked.

Loureiro (1999) developed a System Concurrent Engineering Framework. According to this Framework the definition of product life cycle scenarios, the requirements analysis, functional analysis and physical analysis are carried out, concurrently, for the product and its life cycle performing organizations. The framework and methods associated to it were updated in (LOUREIRO, 2010)

In this paper, for demonstration purposes, the methodology was applied to a high level of the product breakdown structure. In practice, however, the method should be applied to all levels of the system hierarchy for product and organization.

2. Product life cycle

In this method, the initial development of a product should be through the definition of its life cycle (Figure 1). Its stages are: Conception, Development, Operation, Maintenance and Disposal. All scenarios are presented as decomposition of those stages. The symbol (AND) means

that all scenarios must be executed. The symbol (OR) means that the execution of the scenarios is optional.

The scenarios which are part of the scope of the system development effort are highlighted in the Figure 1. The red color scenarios are within the scope of the activities of the

organization that also develops the product. The blue color scenarios will be further investigated as part of the product operation process.

The diagram IDEF0 (Integration Definition) should be used to represent the flow of inputs and outputs, controls and

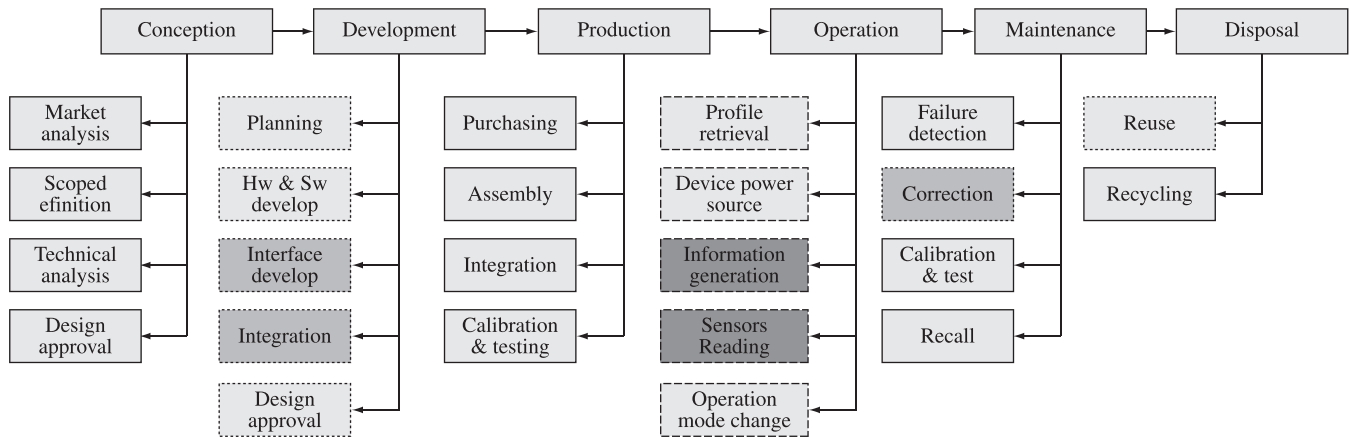

Figure 1. Scenarios of the product life cycle.

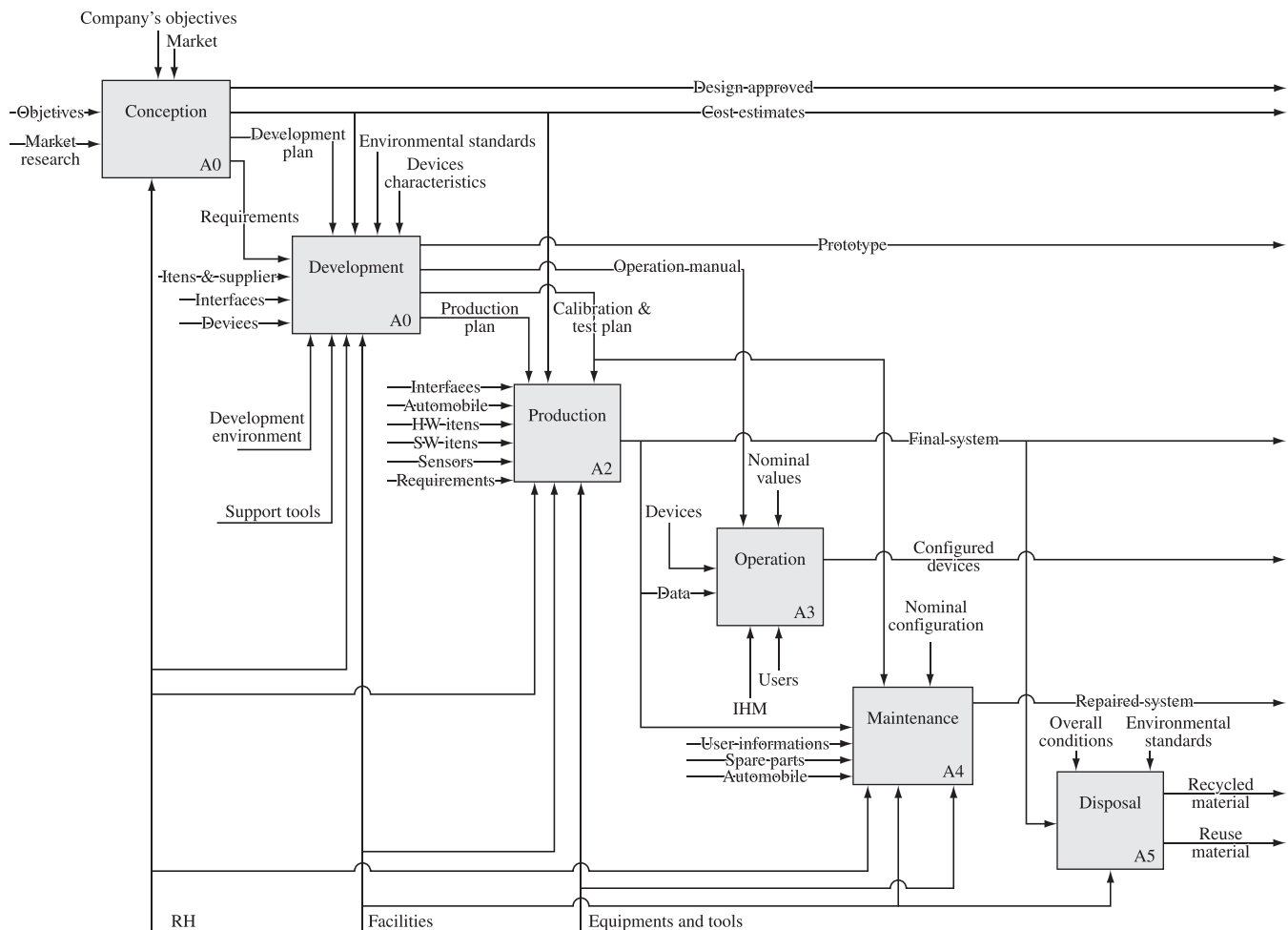

Figure 2. System Life Cycle IDEF0 diagram.

support mechanisms among stages of the system life cycle. In Figure 2, the diagram IDEF0 shows system life cycle. The number zero represents the level that can be increased to represent each step in more detail.

3. Requirements analysis

To identify the system requirements is necessary to identify the Stakeholders involved in each scenario, along with their interests. The Stakeholders are individuals or a group of individuals who directly or indirectly affect or are affected by the product over its life cycle.

For each interest of each Stakeholder must be defined a Measure of Effectiveness (MoEs). Those Measures of Effectiveness express the attributes which the Stakeholders value in the system and guide the definition of system requirements. So, the system requirements are defined

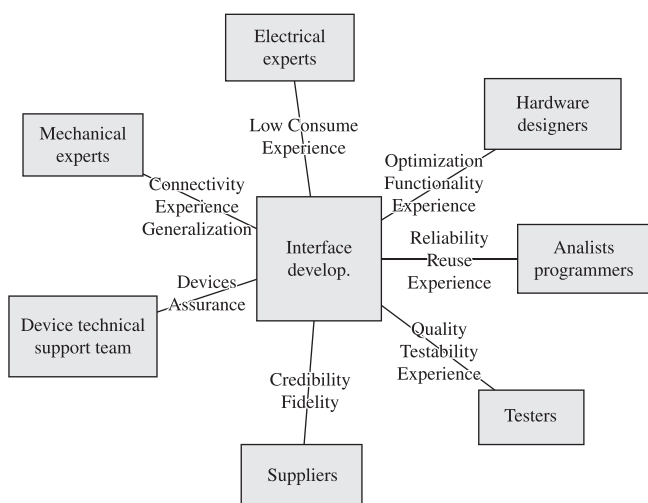

Figure 3. Stakeholders with their interests in the Interface Development Scenario.

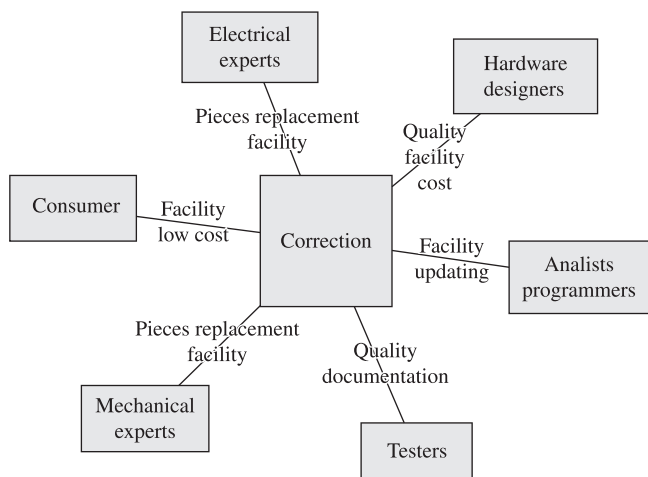

Figure 4. Stakeholders with their interests in the Correction Scenario.

with more quality and precision. Other characteristic is the fact that the stakeholder requirements are not necessarily quantifiable.

Figures 3 and 4 illustrate Stakeholders and their interests in the scenarios of the development organization. Figures 5 and 6 illustrate Stakeholders and their interests in scenarios of the product in operation. It shows that the method allows for the definition of Stakeholder influence in more than one scenario.

For demonstration purpose, a Stakeholder with only one interest was chosen for each scenario, resulting in 4 Stakeholders and 4 interests. Table 1 shows the 4 Stakeholders and their interests and the measure of effectiveness for each interest.

Based on metrics and measures derived from the MOEs, the system requirements and development organization

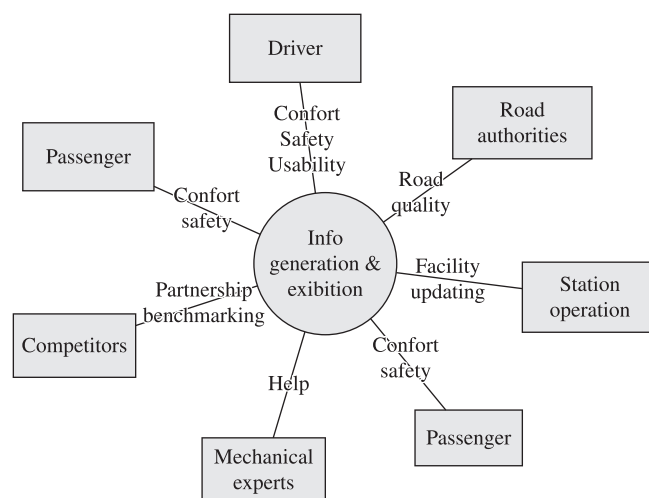

Figure 5. Stakeholders with their interests in the Generation and Display of Information Scenario.

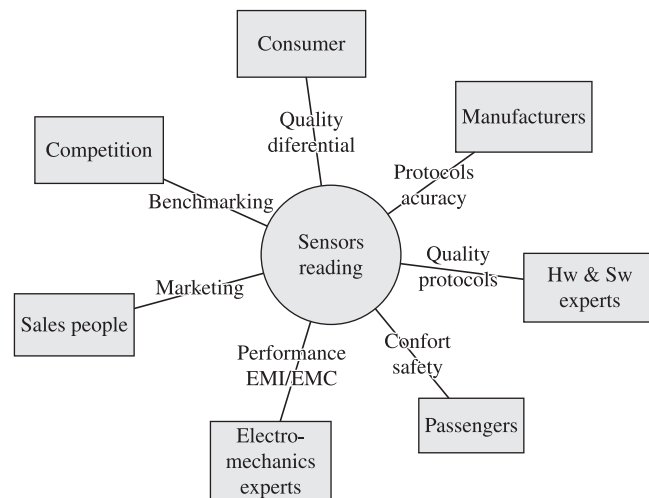

Figure 6. Stakeholders with their interests in the Sensors Read Scenario.

are defined through Requirements Events List. In such list stimulus are what Stakeholders should be able to do and responses are what product or organization elements must do in response to the stimulus. The measure units from MOEs must be used to qualify responses to stimulus. Table 2 show Requirements Events List generated by the same scenarios from Table 1.

After this table is generated, only product and organization requirements can be seen on Table 3. These are requirements that must be used for product implementation.

4. Risk analysis

Risks are events that can happen during a project, generating negative results on the project goals. With the purpose of preventing and handling such events, the risk

analysis is composed of processes that identify, analyze, answer and monitor the events that can interfere over a project.

The risk planning organization is composed by specialists from each area, being it technical, administrative or legal. This practice increases the chance of the main events being considered and handled.

Considering the necessity of minimizing the impacts that could happen on the system, the risk analysis was performed, using the following techniques: risk assessment, failure assessment, passport analysis, GUT priority matrix and the addition of functions to the system, to work against the possible failures detected.

In this paper, the risk analysis was performed for the product operation scenario 'generate and show information'.

Table 1. Stakeholders, goals and measurable itens MOES.

Scenarios	Stakeholders	Goals	MOEs
Interface Development	Tester	Quality	- Accuracy (data precision percentage) - Response Time (milliseconds)
Correction	Consumer	Facility	- Failure detection (seconds) - Correction Time (worked hour)
Info Generation and Exhibition	Driver	Safety	- Tires calibration (boolean) - Enough fuel (boolean)
Sensors Reading	Hardware & Software Experts	Quality	- Response time (milliseconds) - Precision (precision percentage)

Table 2. Requirements Events List.

Stakeholder	The Stakeholder shall be able to...	Requirement	The organization shall be able to...
Tester	Create test case to measure the precision and response time of the system.	Req-010	Available tools able to make the tests.
Consumer	Detect and inform the nearest location the system failure to be repaired.	Req-011	Correct the failure during the 24 hours limit.
			The product shall be able to...
Driver	Capture the need tires calibration.	Req-012	Detect the absence of at least one percent.
Hardware & Software Experts	Develop a solution able to read and process the devices sensors data.	Req-013	Process data read from the sensors to be displayed in a maximum 50 milliseconds.

Table 3. Product and organization requirements.

Req.	Requirement description	Concern	Type (F/P)	Compliance (M/D/O)	Status (OK/TBD/TBC)	Verifiability		
						P/O	T/I/D	Procedure
010	Provide tools to be able to perform tests.	Quality	F	M	OK	O	I	P04
011	Correct the failure in a maximum of 24 worked hours.	Facility	P	D	OK	O	I	P07
012	Detect the absence of at least 1% of the ideal capability of each tire pressure.	Safety	F	M	[TBC]	P	T	P12
013	Process the read data from the sensors to be displayed in a maximum of 500 milliseconds.	Quality	P	M	[TBC]	P	T	P03

Type (F/P): Functional / Physics. Tendency (M/D/O): M-Mandatory, D-Desirable, O-Optional. Status (OK/TBD/TBC): TBD-to be defined, TBC-to be confirmed. P/O: Process, Organization. T/I/D: Test, Inspection, Desirable.

During the hazard analysis of this scenario, the following hazards were identified:

- Fire;
- Device broken;
- Electrical short-circuit;
- Electromagnetic interference;
- Loss of satellite signal;
- Software failure.

After the hazards identification, the next step is to detect what failures can lead to them. So, we performed the cause identification analysis, as shown below:

- Hazard 1: Fire
 - Failure 1: Devices damaged
 - Failure 2: Sensors and cables burned out
 - Failure 3: Information unavailable
- Hazard 2: Device broken
 - Failure 1: Information unavailable
- Hazard 3: Electrical short-circuit
 - Failure 1: Incorrect data
 - Failure 2: Sensors and devices damaged
 - Failure 3: Information unavailable
- Hazard 4: Electromagnetic interference
 - Failure 1: Incorrect data
 - Failure 2: Temporary lack of communication with devices
- Hazard 5: Loss of satellite signal
 - Failure 1: Wrong position information
- Hazard 6: Software failure
 - Failure 1: Wrong information

The passport analysis was performed to detect the physical problems that could happen, as well as the damage that would be caused in the case of failure. Figure 7 presents this analysis.

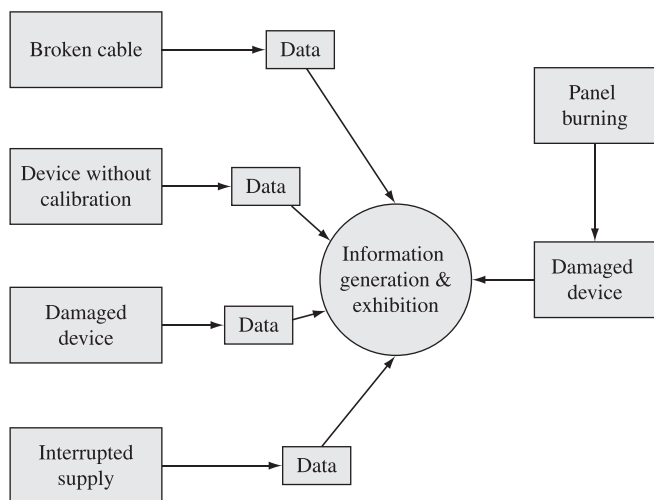

Figure 7. Passport scenario of the product-in-operation.

To determine the relevance of the events that could happen and to prioritize them in the search for preventive measures, it was created a prioritization table, based on the multiplication of the weights defined to three events characteristics: Gravity, Urgency and Tendency. With this analysis, it is possible to verify which event can cause the greatest impact on the system. Table 4 was made using weights 1 to 5, where the greatest value is the one that most impacts the system.

As a consequence of the GUT table values, it was possible to define new system functions, as shown in Table 5, to ensure the safe and the system quality.t

Table 4. Table GUT of product-in-operation scenario.

Risk	G	U	T	Total	Action
Occurrence of the burning in automobile interior.	5	2	3	30	Prevention
Occurrence of the burning at automobile outside.	4	2	3	24	Prevention
Occurrence of the electric short circuit.	5	3	3	45	Protection
Occurrence of the electromagnetic interference.	3	3	3	27	Protection
Damaged device.	3	2	3	18	Detection
Without contact of GPS with the satellite.	2	2	2	8	Detection
Occurrence of the error in system.	3	3	3	27	Correction

Table 5. Generated functions to prevent the occurrence of risk events.

Risk	Action	Generated function
Occurrence of the burning in automobile interior.	Prevention	Insert in the manual on good practices for fire prevention.
Occurrence of the burning at automobile outside.	Prevention	Insert in the manual on good practices for fire prevention.
Occurrence of the electric short circuit.	Protection	Provide fuses for all devices.
Occurrence of the electromagnetic interference.	Protection	Protect the devices of the electromagnetic interference.
Damaged device.	Detection	Provide a function in the software to check the availability of the device.
Without contact of GPS with the satellite.	Detection	Notify the driver that the GPS is not responding.
Occurrence of the error in system.	Correction	Perform Verification and Validation activities by different teams.

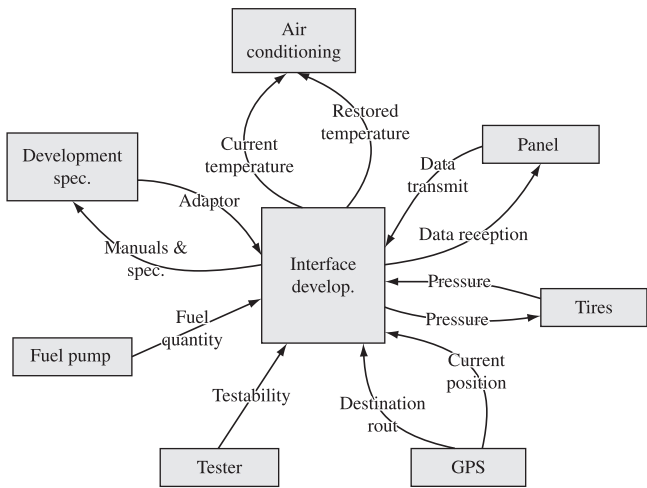

Figure 8. External elements of interface development scenario.

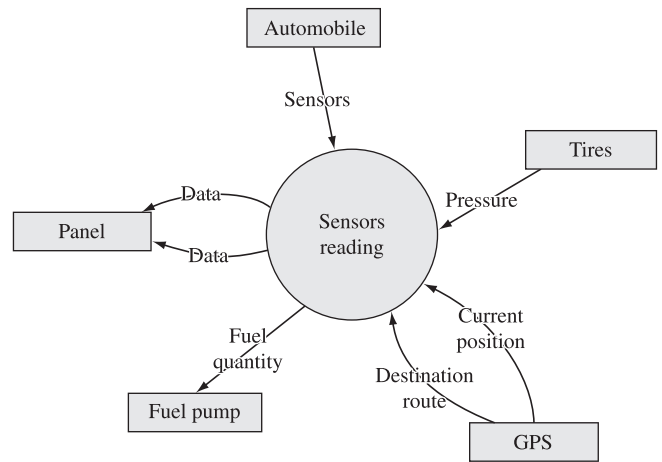

Figure 11. External elements of Sensors Reading scenario.

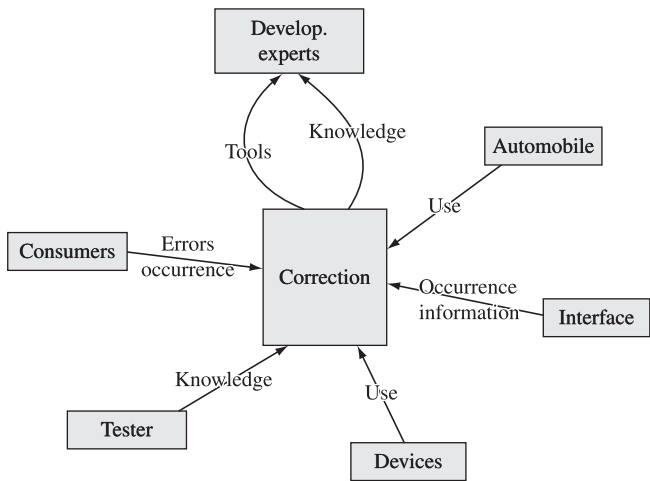

Figure 9. External elements of Correction scenario.

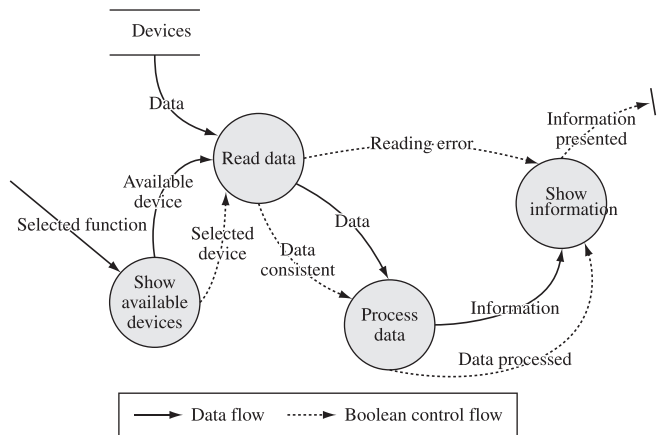

Figure 12. Data flow diagram of the product-in-operation scenario events.

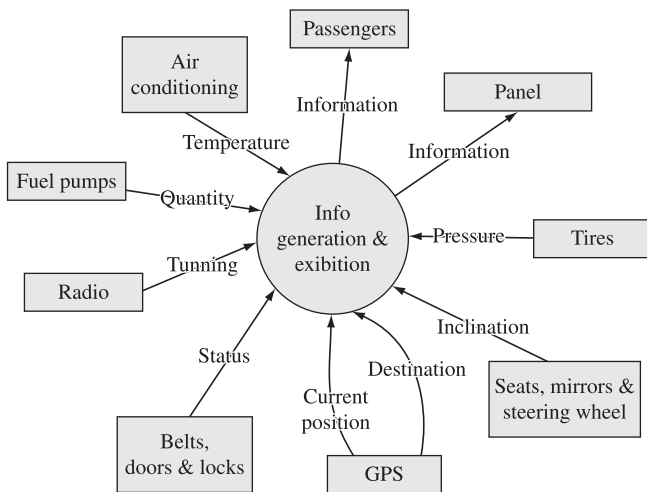

Figure 10. External elements of Info Generation & Exhibition scenario.

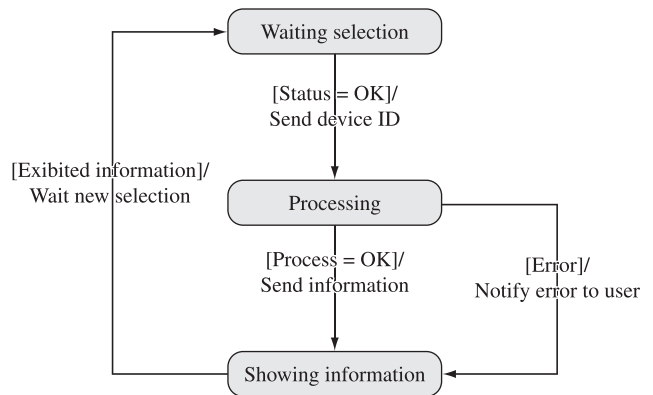

Figure 13. States diagram of the product scenario.

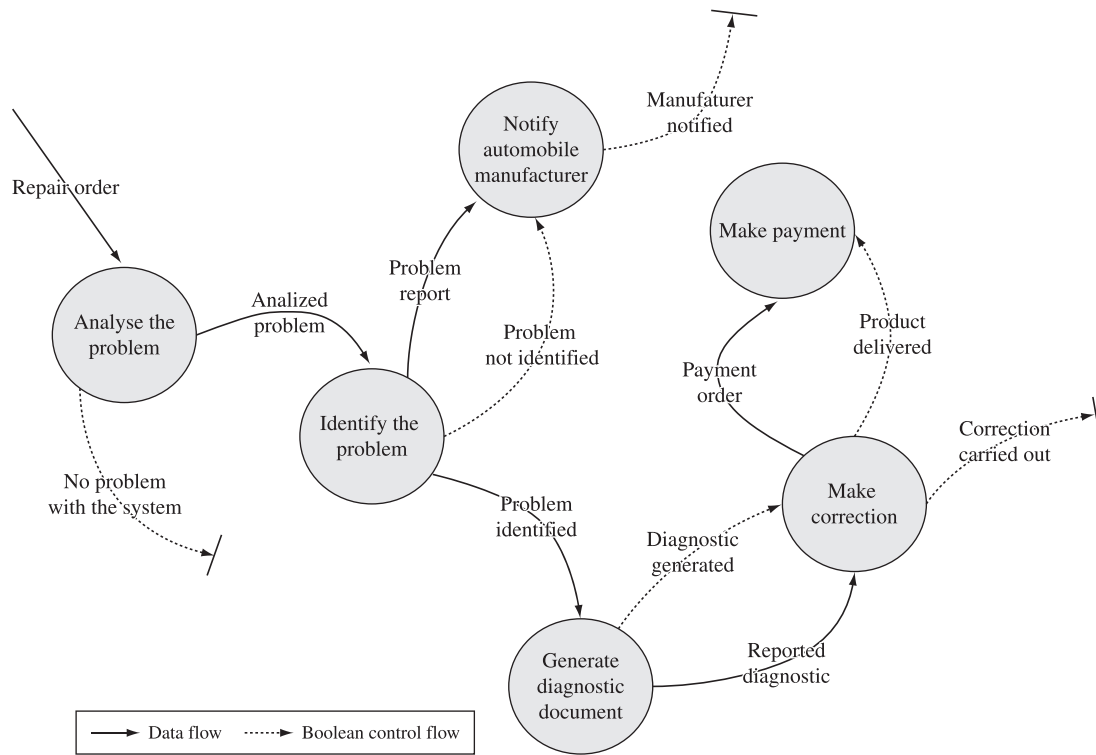

Figure 14. Data flow diagram of the Correction Scenario.

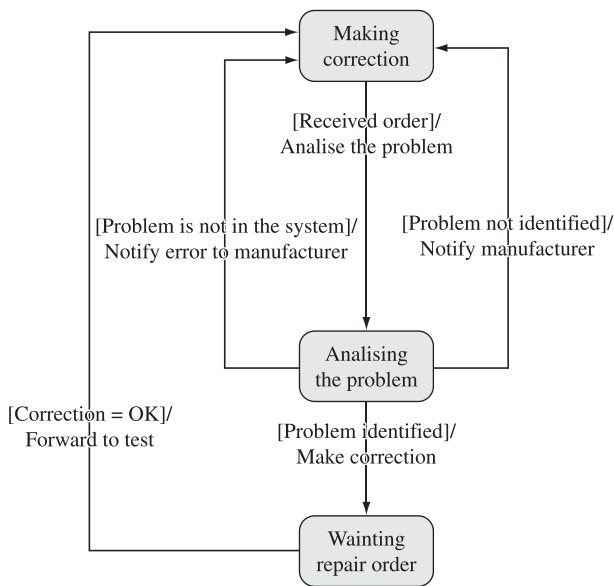

Figure 15. State diagram of the organization scenario.

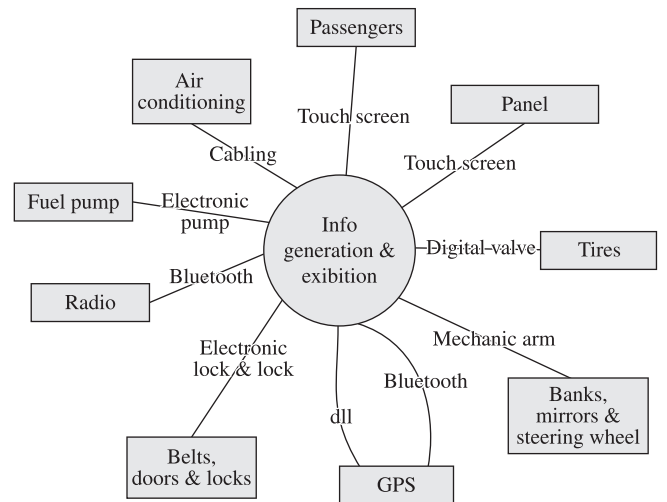

Figure 16. External physical interface of the Information Generate & Exhibition scenario.

Table 6. Event list of Info Generation & Exhibition Scenario.

Driver	System
Select option on panel touch screen.	Display available devices.
Select device.	Display information.

Table 7. Event list of Correction scenario.

Organization	Development Experts
Send repair order.	Identify problem.
Generate diagnostic document.	Make correction.
Deliver product.	Call payment order.

5. Functional analysis

The functional analysis is performed to identify the system functionalities. The first step is the definition of the external and/or external physical elements and their interfaces, responsible for the material, energy and information exchange between the external elements and the system of interest. It shall be defined, also, the states of each element and the modes of each scenario. Each mode is activated as a function of the external element states, also called circumstances. Figures 8 and 9 illustrate the physical elements and their interfaces for the organization scenarios, and Figures 10 and 11, for the product-in-operation scenarios.

The next step is the extraction of system functions through the construction of the Events List. With the generation of this list, we can extract the system functions, and/or the functions of the development organization. Based on the actions performed by the stakeholders, the capabilities

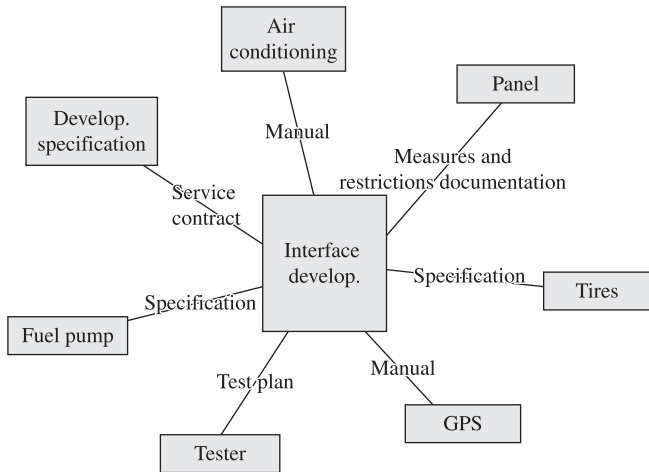

Figure 17. External physical interface of the Interface Development scenario.

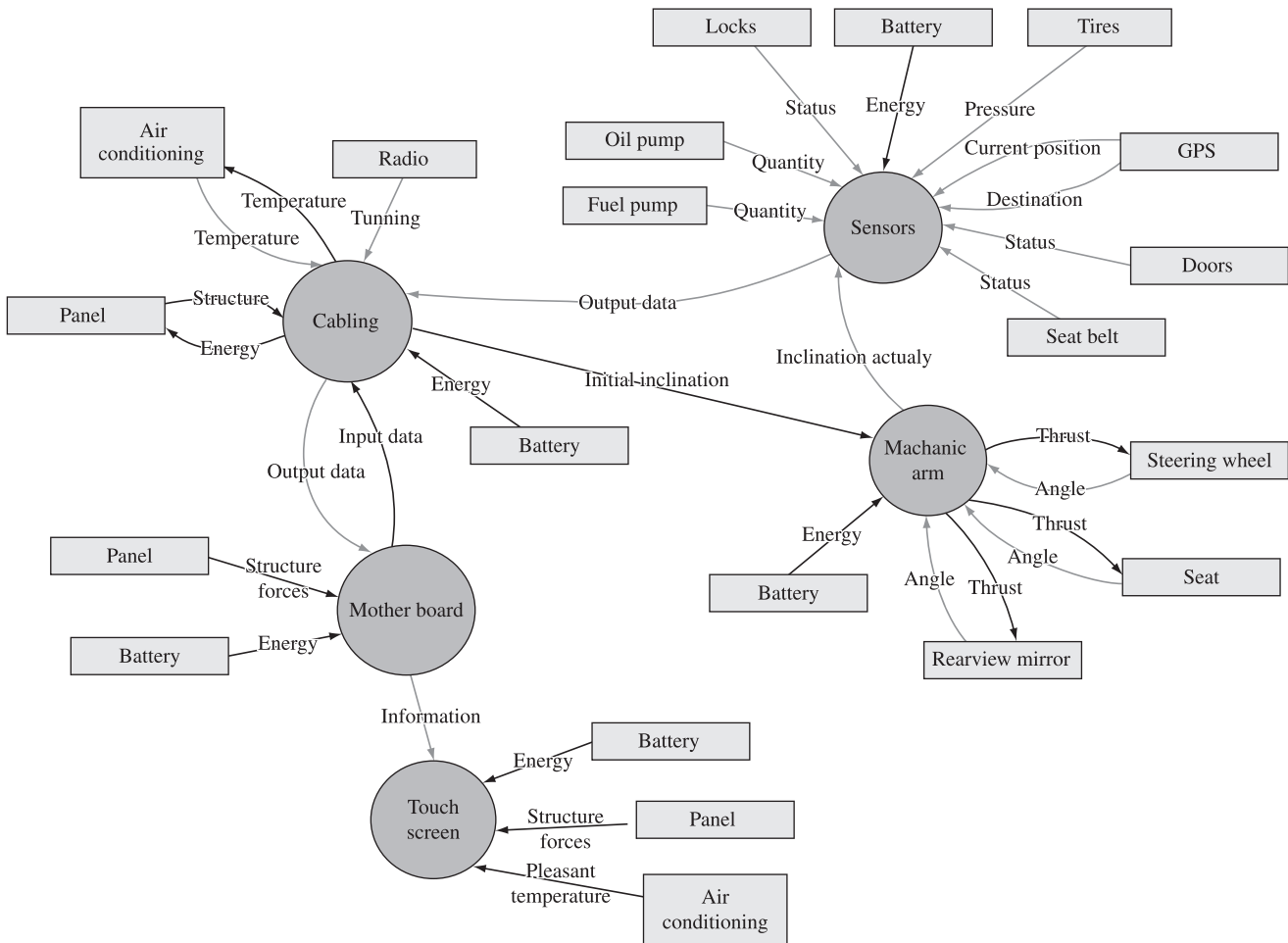

Figure 18. Physical elements of the Information Generation & Exhibition scenario.

needed for the scenario execution are identified. In this stage, only one product and one organization scenarios, with one stakeholder each, were chosen for demonstration. Tables 6 and 7 shows the result of the Events List for the stakeholder of Information Generation and Display, and for the stakeholder of the Correction scenarios.

The data flow diagrams corresponding to those scenarios were drawn, along with the state transition diagrams.

Table 8. Functional allocation of the physical elements product-in-operation scenario.

		Elementos físicos				
		Cabling	Sensors	Mechanic arm	Mother board	Touch screen
Functions	Display available devices.					X
	Data reading.	X	X	X		
	Data processing.				X	
	Display information.					X

Figures 12 and 13 show the diagrams for the Information Generation and Display scenario, whereas Figures 14 and 15 illustrate the Correction scenario diagrams.

6. Physical analysis

The same external environment elements identified during the Functional Analysis are used on the Physical Analysis, but the interfaces between the system in a

Table 9. Functional allocation of the physical elements Correction scenario.

		Physical elements		
		Input courtyard	Office	Repair room
Functions	Analyze the problem.	X		
	Identify the problem.	X		
	Generate diagnostic document.		X	
	Make correction.			X
	Make payment.		X	
	Notify manufacturer.		X	

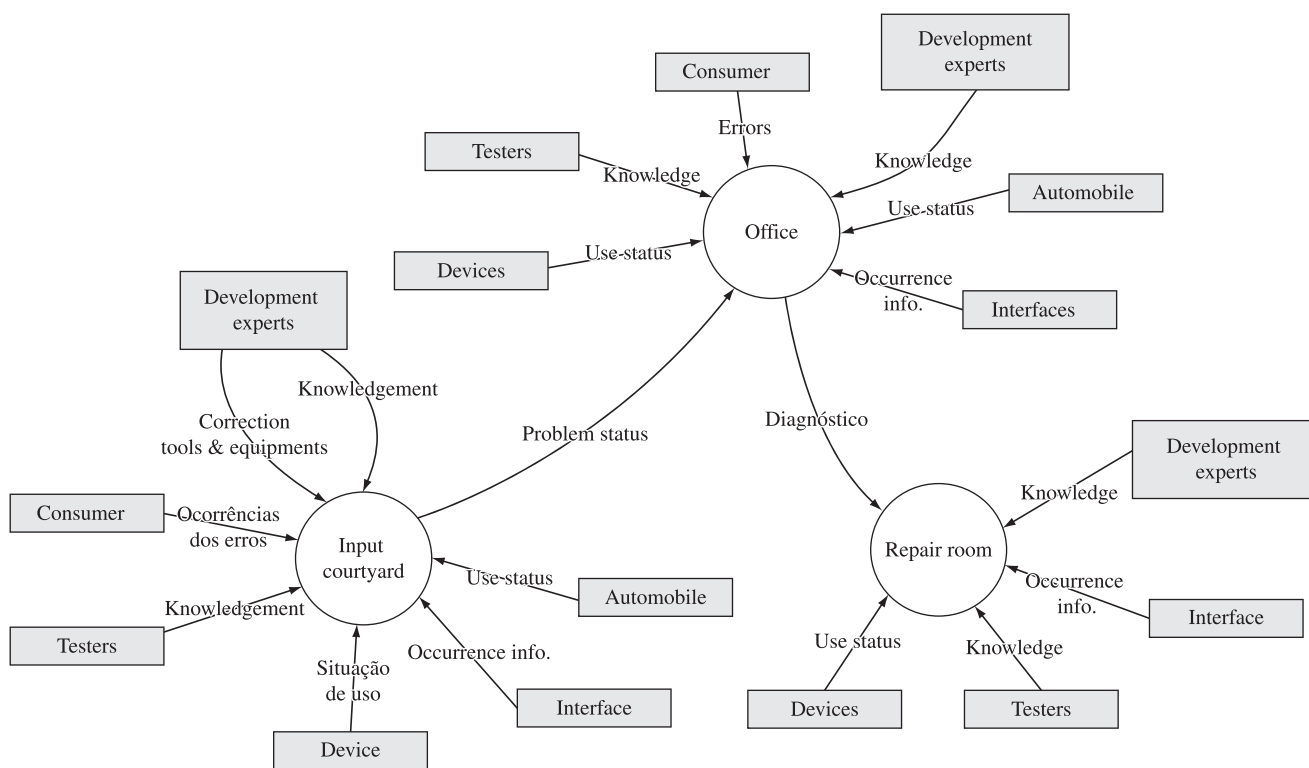

Figure 19. Physical elements Correction scenario.

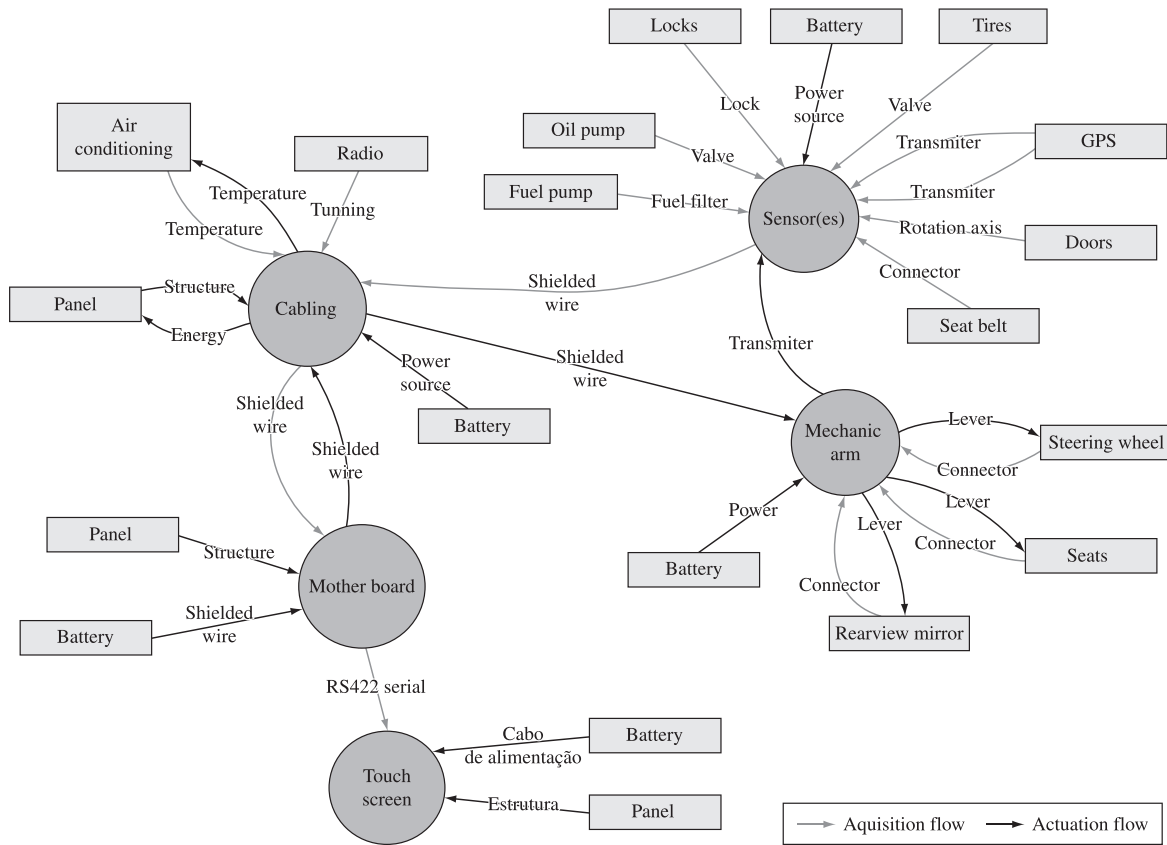

Figure 20. Physical interface between the physical elements Information Generation & Exhibition scenario.

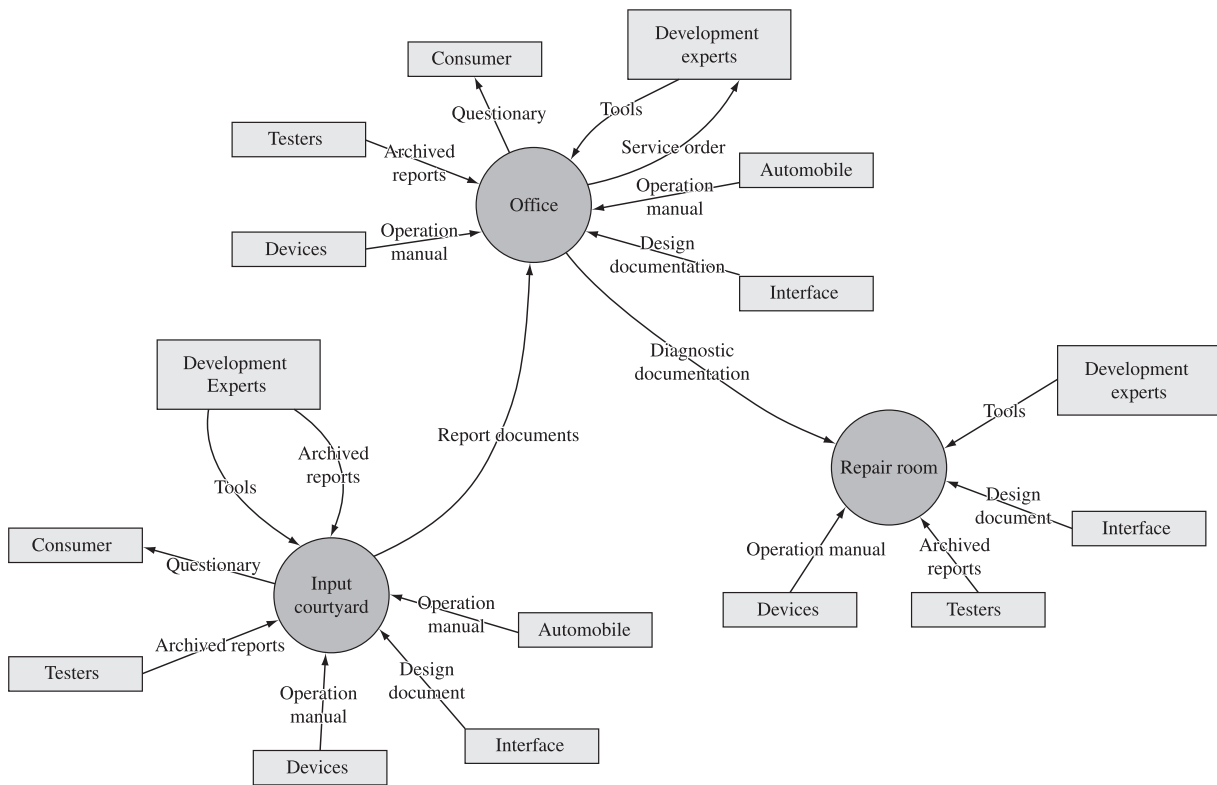

Figure 21. Physical interface between the physical elements Correction scenario.

given scenario and the external elements are physical. Figures 16 and 17 illustrate these interfaces for the Information Generation and Display, and for the Interfaces Development. The same was performed for the other scenarios, but are not described in this paper.

Then, the elements were organized to demonstrate how they physically connect to each other and how they interact concerning the material, energy, and/or information exchange, using the Flow Diagram, as shown in Figure 18. Once this analysis is done, the functions shall be allocated to these physical elements. Table 8 shows the functional allocation to the physical elements of the Information Generation and Display scenario.

The same was performed to the Correction scenario (that is a development organization scenario), as shown in Figure 19 and Table 9.

To finish the process it is necessary to define the physical interfaces for the two scenarios described above. Figures 20 and 21 illustrate it. The red arrows of Figure 20 represent the flow of the data acquired by the device sensors.

7. Conclusion

The development of complex products through the Concurrent Systems Engineering is concluded with the allocation of system functions to their physical components. It is worth noting that all the stages described in this paper were performed without any implementation and/or product manufacturing. This is a key characteristic of Concurrent Engineering, to advance stages commonly performed later. This way, many risk situations can be detected even before the start of a product mass production.

8. References

- LOUREIRO, G. **A systems engineering and concurrent engineering framework for the integrated development of complex products**. Thesis (Ph.D.)-Loughborough University, 1999.
- LOUREIRO, G. Lessons learned in 12 years of space systems concurrent engineering. In: INTERNATIONAL ASTRONAUTICAL CONGRESS, 61., 2010, Prague, Czech Republic. **Proceedings**... Paris: IAF, 2010. p. 1995-6258